

\$1.00

*hr*_{mw}

focus
on
communications
technology . . .

ham **radio**

magazine

FEBRUARY 1975

2304-MHz power amplifier

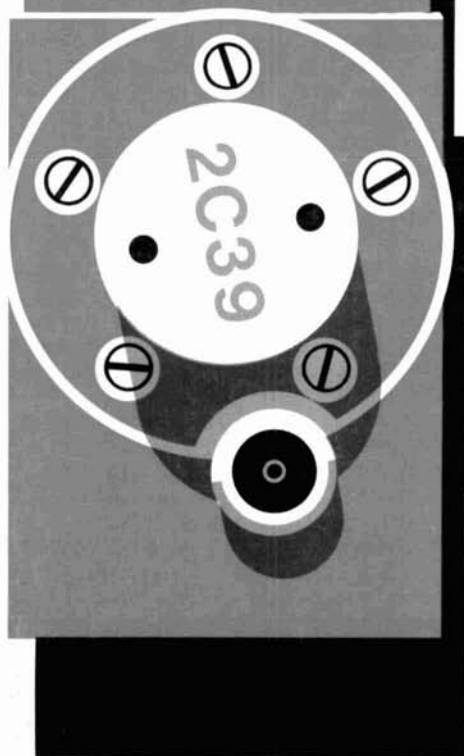

this month

- bandpass filter design 18
- speech processing 28
- RTTY terminal unit 36
- GHz frequency scalars 38

BUY OUR ANTENNA... OPEN THE BOX... ASSEMBLE IT EASILY...

IT WORKS

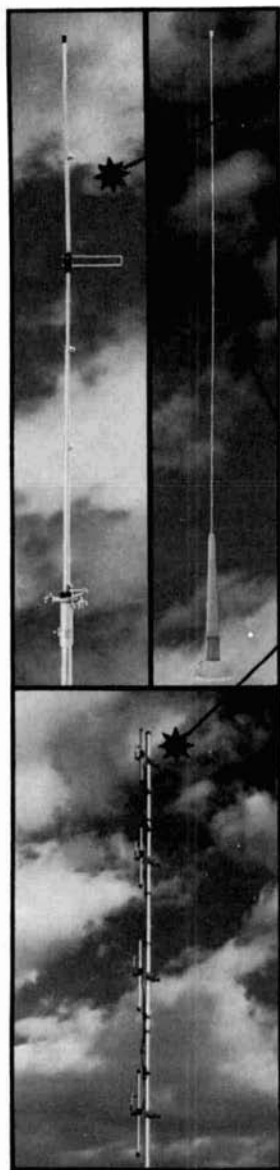

NEW FM GAIN RINGO RANGER...you'll say "IT WORKS", when you try this exciting new antenna! Ringo Ranger is even better than the popular Ringo. Ranger has more gain for extended range. Easily mounted on a mast or existing tower, Ranger consists of a one eighth wave phasing stub and three half waves in phase to concentrate your signal at the horizon where it can do you the most good. Your present AR-2 can be extended with a simply installed RANGER KIT.

ARX-2	100 watts	146-148 MHz	\$26.50
ARX-220	100 watts	220-225 MHz	\$26.50
ARX-450	100 watts	435-450 MHz	\$26.50
ARX-2K	Ranger Kit		\$10.95

NEW FM MOBILE ... Fiberglass 5/8 wave professional mobile antenna for roof or trunk mount. Superior strength, power handling and performance.

AM-147T	146-175 MHz	mobile	\$29.50
---------	-------------	--------	---------

NEW 4 POLE...economically priced for primary repeater or home QTH, this antenna has been proven in hundreds of repeater installations. It is a four dipole gain array for mast or tower mounting. It has sealed coax harness for direct 52 ohm feed.

The antenna can be adjusted for a 180° or 360° radiation pattern. Another unmatched antenna value by Cush Craft.

AFM-4D	1000 watts	146-148 MHz	\$52.50
AFM-24D	1000 watts	220-225 MHz	\$48.50
AFM-44D	1000 watts	435-450 MHz	\$46.50

center support mast not included

IN STOCK WITH YOUR LOCAL DISTRIBUTOR



cushcraft
CORPORATION

621 HAYWARD ST., MANCHESTER, N.H. 03103

Give Your Signal A
DOUBLE BOOST
And Spend More Time Communicating



1

Let an ALPHA 374 Bandpass Linear deliver all the power you can legally use (in any mode, continuously!) and eliminate the chore of amplifier tune-up, too. Using a '374, maximum legal power with true 'instant band change' is a reality.

2

Add even more punch and crispness to that big signal with a Magnum Six rf speech processor (or a DX Engineering model, if you prefer). The rugged *continuous duty* ALPHA 374 easily handles the extra *average power* demanded by an effective rf speech processor. Buy a "no-tune-up" '374 in February and we'll sell you an rf processor for *ONE-THIRD price!*

With *any* ALPHA maximum-legal-power linear you'll enjoy a new level of convenience and operating pleasure. Don't wait — see your dealer or contact ETO now for details.

The ALPHA 77D "ULTIMATE LINEAR" — latest in the fabulous ALPHA Seventy series — is now available. Call or write for information.

ETO

EHRHORN TECHNOLOGICAL OPERATIONS, INC.
BROOKSVILLE, FLORIDA 33512
(904) 596-3711



For Those Who Demand The Finest

MODEL CX-11... *Deluxe Integrated Station*

9 New Features

New solid state broadband linear power amplifier 10-160 meters. 150 Watts DC output — requires no tuning, operates into any VSWR — continuous duty at full rated output.

New concept front-end design — utilizing double active balanced mixers for unmatched sensitivity, blocking and cross-modulation rejection.

Solid-state modular construction utilizing gold-plated, pins and plug-in sockets for all transistors, IC's, and circuit board connectors.

Five Bandwidths of selectivity are standard — 2.4, 1.5, 1.0, .4, .1 kHz.

Peak notch filter with adjustable frequency notch depth and Bandwidth controls.

RTTY narrow and wide shift FSK-LSB.

Built-in electronic Keyer with independent speed and weight control and partial or full dot memory.

Built-in Power Supply completely self-protecting — both thermal and current overload, integrated circuit controlled.

New six-digit frequency counter utilizing new 1/2 inch amber or red LEDs optimized for a non-blinking, stable display.

ADDITIONAL FEATURES

Dual VFO's for transceive, split operation, or dual receive.

Adjustable IF shift.

Receive or transmit offset tuning.

Push Button spotting.

Adjustable R.F. clipping.

Instantaneous break-in CW.

Built-in Wattmeter.

Built-in noise blanker.

Adjustable R.F. power output.

Pre-IF, adjustable noise blanker.

Now in production at \$2600

Distributed by

PAYNE RADIO

BOX 525, SPRINGFIELD, TENNESSEE 37172

Phone (615) 384-5573 — Nights (615) 384-5643

In Sweden contact:

SB COMMUNICATIONS

Palmtorpsvagan 3

S-640 20 Björkvik, Sweden

Phone or Write DON PAYNE, K4ID for a brochure and a trade on your gear.

Due to our tremendous growth — openings now available for communications design engineer, engineering aids and technicians.

Complete Parts & Service At The Factory



Box 127 Franklin Lakes, NJ 07417

Tel: (201) 891-0459

February, 1975
volume 8, number 2

staff

James R. Fisk, W1DTY
editor-in-chief

Patricia A. Hawes, WN1QJN
assistant editor

J. Jay O'Brien, W6GDO
fm editor

James A. Harvey, WA6IAK
James W. Hebert, WA8OBG
Alfred Wilson, W6NIF
associate editors

Wayne T. Pierce, K3SUK
cover

T.H. Tenney, Jr., W1NLB
publisher

offices

Greenville, New Hampshire 03048
Telephone: 603-878-1441

ham radio magazine is
published monthly by
Communications Technology, Inc
Greenville, New Hampshire 03048

subscription rates

U.S. and Canada: one year, \$8.00
two years, \$13.00; three years, \$18.00
Worldwide: one year, \$10.00
two years, \$17.00; three years, \$24.00

Foreign subscription agents
Canada
Ham Radio Canada
Box 114, Goderich
Ontario, Canada N7A 3W9

Europe
Ham Radio Europe
Box 444
194 04 Upplands Vasby, Sweden

France
Ham Radio France
20 bis, Avenue des Clarions
89000 Auxerre, France

United Kingdom
Radio Society of Great Britain
35 Doughty Street
London WC1N 2AE, England

African continent
Holland Radio, 143 Greenway
Greenside, Johannesburg
Republic of South Africa

Copyright 1975 by
Communications Technology, Inc
Title registered at U.S. Patent Office
Printed by Wellesley Press, Inc
Framingham, Massachusetts 01701, USA

Microfilm copies of current and
back issues are available from
University Microfilms
Ann Arbor, Michigan 48103

Second-class postage
paid at Greenville, N.H. 03048
and at additional mailing offices



contents

8 2304-MHz power amplifier
Norman J. Foot, WA9HUV

18 receiver pre-selection filters
Wesley H. Hayward, W7ZOI

28 speech processing
Barry J. Kirkwood, ZL1BN

36 phase-locked RTTY terminal unit
Nathan H. Stinnette, W4AYV

38 uhf frequency scalars
Douglas R. Schmieskors, WB9KEY

41 HW202 frequency scanner
Kenneth S. Stone, W7BZ

44 transistor breakdown voltages
James E. McAlister, WA5EKA

50 mosfet circuits
Edward M. Noll, W3FQJ

4 a second look
94 advertisers index
83 flea market
58 ham notebook

60 new products
94 reader service
6 stop press

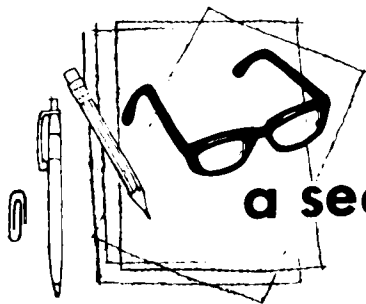

a second look

by jim
fisk

The FCC finally released its long-rumored "amateur restructuring" proposal in mid December which, among other things, would create two new amateur license classes and re-arrange the frequency, power and emission privileges. And, as so often happens, early truncated reports of Docket 20282 were rushed into print so quickly that they glossed over some important details — details which, when presented in the proper light, would clear up most of the misunderstandings which many amateurs apparently have about the sweeping new proposals outlined in the 29-page Docket.

First, and most important, if the proposal is adopted *presently* licensed amateurs would gain much more than they lose. True, separate high-frequency and vhf licenses are proposed, but *present* General and Advanced Class licensees may obtain their counterpart vhf licenses simply by request. In addition, Advanced Class licensees would gain use of the high-frequency radio-telephone segments now reserved for the Amateur Extra Class as well as a maximum power limitation of 2000 watts PEP *output*, a substantial increase. Advanced Class licensees would lose their operating privileges above 29 MHz (including 29.0 to 29.7 MHz) but only until they applied for and received their Experimenter license, the new vhf counterpart to the Advanced Class which carries all operating privileges above 29 MHz.

General Class licensees would retain their present operating privileges below 29 MHz with a permissible maximum power limitation of 500 watts PEP

output. Considering the average efficiency of rf power amplifiers, this represents only a modest decrease from the present power level. To regain their vhf privileges above 50 MHz Generals would have to apply for a separate Technician Class license — no additional examinations would be required. *New* licensees would, however, be required to pass separate examinations for each class of license they desired.

Under the new proposal the Novice Class license would be renewable for five-year terms as the other classes are now, and the maximum power limitation would be 250 watts *input*, another substantial increase. Since Novice licensees are limited to CW operation, the Commission felt that the traditional "voltage times current" measurement of input power was still appropriate; such is not the case with other, more advanced modes such as single sideband and slow-scan television. Under the new proposal Technician Class licensees (or other vhf licensees, for that matter) could also hold the Novice Class, an option not now available.

The newest, and in some ways most exciting, proposal contained in Docket 20282 is the Communicator Class license — a code-free amateur license which would offer use of all amateur frequencies above 144 MHz, F3 emission only. The size of the Amateur Radio Service has declined measurably in recent years and the new Communicator Class should do much to start our ranks growing again. Some amateurs are opposed to the idea of a code-free license simply as a matter of tradition,

(continued on page 43)

DIGITAL!



DV-21

The perfect companion for your IC-21A, the DV-21 is an all new unique digital VFO to complete your ICOM 2 meter station. The DV-21 will operate in 5 or 10 KHz steps over the entire 2 meter band. It can also scan either empty frequencies, or the frequencies being used, whichever you select. Complete, separate selection of the transmit and receive frequencies, is as simple as touching the keys. When you transmit, bright easy to read LEDs display your frequency. Release the mic switch, and the receive frequency is displayed. There are also two programmable memories for your favorite frequencies.

You won't believe the features and versatility of the DV-21 until you've tried it. It's new, and it's from ICOM.



Distributed by:



ICOM

ICOM WEST, INC.
Suite 232 - Bldg II
300-120th Ave. N. E.
Bellevue, Wash. 98005
(206)454-2470

ICOM EAST Div. ACS Inc.
Suite 509
13777 N Central Expwy
Dallas, Texas, 75231
(214)235-0479

presstop

OSCAR 7 ORBITAL PERIOD has been determined to be 114.945 minutes, sufficiently shorter than initially reported to account for the incorrect arrival times in early orbital predictions. The error was NORAD's -- their tracking station had confused the rocket's second stage with OSCAR 7! The corrected figure for earth movement between orbits is now 28.74° at the equator.

Complete Updated Orbital Data for OSCAR 6 and OSCAR 7 will be provided monthly as an added slip-in sheet to HR Report. Copies of these predictions are available to all interested readers upon receipt of an SASE (one SASE for each month).

OSCAR 6 Is Being Abused, and AMSAT officials are concerned. It is important to 6's future that it be used only during the scheduled on periods, even though it may be found on at other times. Limit your use of OSCAR 6 to Monday, Thursday and Friday (GMT) for afternoon or evening contacts, plus Sunday mornings.

MORE MOONBOUNCE TESTS planned for February from WA6LET, using Stanford's big dish on 144.190 and 432.190 and listening down about 90 kHz. Operating schedule will be 0500-1000Z February 2 and 0000-0500Z February 23, with WA6LET transmitting the first half of each minute and listening for callers the second half. For further details write Victor R. Frank, Stanford Research Institute, Bldg. 320A, 333 Ravenswood Ave., Menlo Park, California 94025.

FCC POLICY REGARDING CODED TRANSMISSIONS (Presstop, January) has been receiving further study at the Commission. It appears now that control signal transmissions will not be involved, and only telemetered data transmissions would require disclosure. Until specific details of a procedure for advising the FCC of your telemetry transmissions have been worked out, the requirement for advising local FCC offices has been withdrawn. Full details on the procedure will be provided when they become available.

REPEATERS STILL OPERATING WITHOUT WR CALLS are about to get the axe -- FCC believes it has now processed all on-hand applications for "grandfathered" repeaters, so if you are still waiting you'd better check with the FCC in Washington. FCC records show that more than forty early repeater applications that were returned to the applicants for further information have never come back to the Commission for action.

WVW HAS ADDED USEFUL PROPAGATION INFO to its 14-minute-after-the-hour current radio conditions report. "K Index" refers to current geomagnetic conditions: 1-2 is okay but watch out for 3 or 4. The-higher-the-better is the rule for solar flux. Anyone who plots this information on an hour-by-hour basis and correlates it to conditions on the various bands might find he had developed a nice competitive weapon for stalking DX!

KLM'S AD FOR NEW 2-METER TRANSCEIVER will break this month -- it's a 10-watt PEP frequency-synthesized CW/SSB rig ideal for two-meter DXing and OSCAR work, according to Mike Stahl, K6MYC. Called the ECHO II, this diminutive 8-pound package features a built-in noise blanker, CW break-in, and receiver RIT and comes set up for 145.0-145.23 and 145.77-146.0 MHz. Price is \$389, and KLM plans some nice package deals with solid-state linear amplifiers and antennas. For more info write to KLM Electronics, Dept. H, 1600 Decker Avenue, San Martin, California 95046.

CENTENNIAL CALL SIGN ideas for 1976 still wanted by FCC. Ground rules are that special prefixes must be "self-assignable" and non-ambiguous. In addition to present W/WA-WZ and K/KA-KZ blocks, AA-AL, N and NA-NV may also be used. The catches are to avoid any presently used prefixes (KA, K8, WP and WL, for example) and those likely to show up as part of the restructuring effort. Send your ideas to Prose Walker at the FCC now as work is expected to begin on the project almost immediately.

Introducing the 5 BAND ATLAS-210

SOLID STATE SSB TRANSCEIVER

200 WATTS* P.E.P. INPUT . . . 10,15,20,40, and 80 Meters



\$599

...And the companion model, Atlas-215, which covers
15, 20, 40, 80, and 160 Meters.

- ★ **Frequency Ranges, Atlas-210:** 3700-4050, 7000-7350, 14,000-14,350, 21,100-21,450, and 28,400-29,100 KHz. Model 215 deletes 28,400-29,100 band, and instead covers 1800-2000 KHz.
- ★ **Power Rating:** 200 watts P.E.P. Input and CW Input. *On 10 meters the power rating is 120 watts.
- ★ The same outstanding performance, reliability, and compact size as the Atlas-180 . . . Only 3½ in. high, 9½ in. wide, 9½ in. overall depth, and only 7 lbs. total weight . . . Operates directly from 12-14 volts D.C. All solid state, modular construction . . . No transmitter tuning (special Braille dial available for blind operators at no extra cost).
- ★ **Plug-In Design,** for quick removal from mobile mounting, and insertion into AC Console as illustrated.

★ Prices	
Model 210 or 215	\$599
AC Console, 117 volts 50-60 cycles	\$129
AC Console, 117-230 volts	\$139
Mobile Plug-in Kit	\$ 44
D.C. Battery Cable	\$ 12
Mobile Bracket Kit	\$ 6
Mobile Antenna Transformer	\$ 24



AMERICAN MADE AND GUARANTEED BY



ATLAS
RADIO INC.

490 Via Del Norte
Oceanside, California 92054

Phone (714) 433-1983

Available NOW at your Atlas dealer. See him for complete details, or drop us a card and we'll mail you a brochure and dealer list.

73 Herb Johnson W6QK1

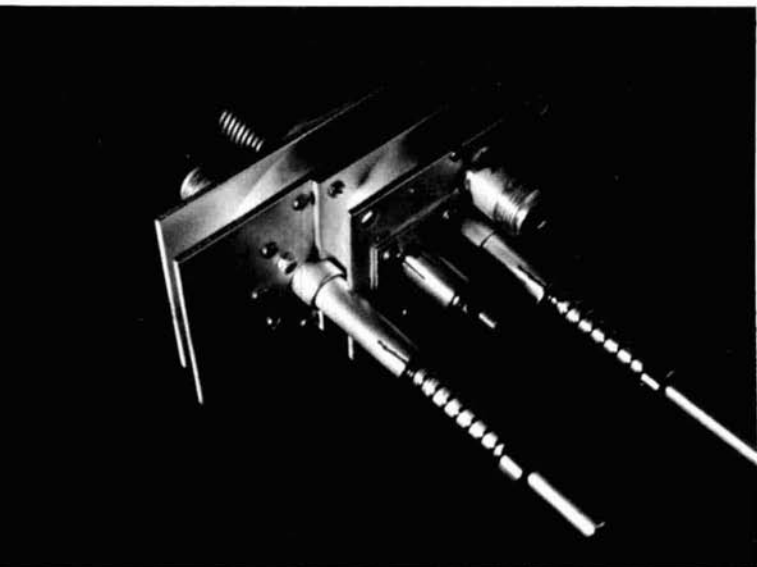

2304-MHz power amplifier

Complete construction
details for a
single-tube
2304-MHz amplifier
that delivers
30 watts output
and up to 13-dB gain

Norman J. Foot, WA9HUV, Elmhurst, Illinois 60216

Of the many varieties of special-purpose tubes which give good performance on the uhf bands and above, the 2C39 remains as the outstanding candidate for amateur use because it is readily available and the price is right. The recent onslaught toward achieving high power on 1296 MHz is directly attributable to the use of the 2C39 and its derivatives. Numerous single-tube designs were initially reported in the amateur publications, followed by multiple tube designs^{1,2} and, finally, the popular octet of 2C39s described by Peter Laakmann³ in 1968.

More recently, interest in 2304 MHz has been growing, and a few pioneering efforts to achieve reasonable rf power without the help of high power klystrons have been reported.

This article is concerned with the design of a 2304-MHz power amplifier which uses a single 2C39 tube. Calorim-

eter measurements show that 30 watts of rf power output at 25% plate efficiency are achievable with a nominal power gain of 13 dB. The design is rugged and performance is stable. All of the parts for this power amplifier can be made with hand tools with the excep-

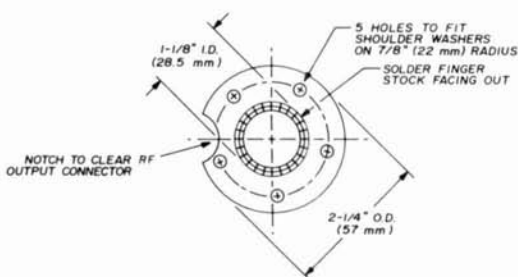

fig. 1. Plate ring for the 2304-MHz power amplifier. This ring is mounted on the output plate (fig. 2) with a 10 mil (0.25 mm) Teflon insulating sheet. Material is 1/8" (3mm) brass.

tion of the cavity rings; these should be cut and faced off in a lathe. The filament and cathode socket parts were obtained from surplus 2C39 amplifiers.

The only parts requiring soldering with a torch are the finger stock, the tuning bushings and the type-N input and output connectors. All other parts are screwed together, including the cavity rings. Like its 1296-MHz counterpart, the 2304-MHz 2C39 amplifier uses cavity resonators in both the cathode and plate circuits. Both cavities are 3/8-inch (9.5-mm) long. The cathode cavity has a 2-inch (51mm) inside diameter while the inside diameter of the plate cavity is 1-3/4 inch (44.5mm).

Although the cavity volumes are relatively small, there is room enough for the 2C39, a piston tuning capacitor and a type-N coaxial connector if the parts are positioned as illustrated. By necessity the 2C39 is located very close to the edge of the cavity. This physical constraint is fortuitous however, since

the input and output impedances of the 2C39 are lower at 2304 MHz than at 1296 MHz. Adequate cavity coupling is achieved when the tube is mounted close to the cavity wall as shown in the photographs.

The grid cavity is made of 2¼-inch (57mm) OD brass tube with a 2-inch (51mm) ID. The 1/8-inch (3mm) wall thickness can be drilled and tapped for 2-56 screws if reasonable care is taken. The original 2304-MHz 2C39 amplifier I built also used 2-inch (51mm) ID tubing for the plate cavity but a 2-inch (51mm) OD ring, 1-3/4-inch (44.5mm) ID, was slipped inside of the cavity to bring the resonant frequency up to 2304 MHz. If desired, the plate cavity ring can be a single unit, 2-1/4 inch (57mm) OD and 1-3/4 inch (44.5mm) ID.

plate assembly

The plate assembly consists of the 1-3/4-inch (44.5mm) ID plate cavity (fig.

Side view of the 30-watt 2304-MHz amplifier showing the 2C39 and output connector (top), plate cavity, cathode cavity and tuning pistons.

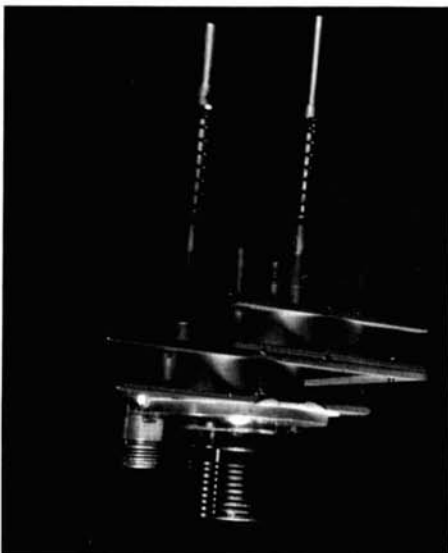

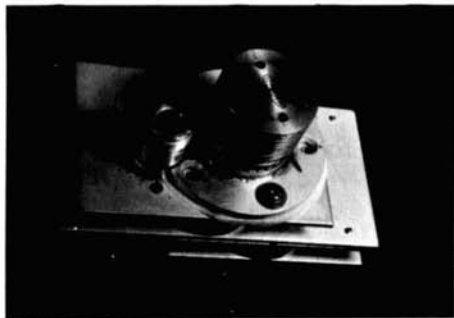
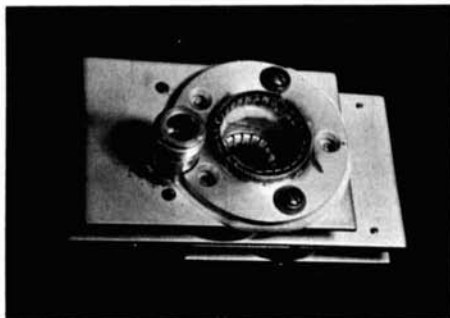

View from the plate output side of the amplifier, with and without 2C39 installed.

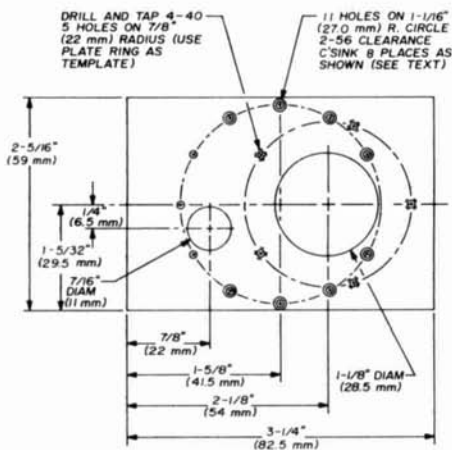

fig. 2. Dimensions for the output plate (out-side face). Material is 0.093" (2.5mm) brass.

1) sandwiched between the output plate (fig. 2) and the grid partition (fig. 3). The plate ring with its finger stock is mounted on the outside of the output plate with a 10 mil (0.010 inch or 0.25mm) Teflon insulating sheet. The 11 holes on the output plate are drilled 30° apart on a 1-1/16-inch (27mm) radius circle. Eight of these holes are countersunk for flat-head 2-56 screws so that the plate ring will mount flush. The output plate is used, in turn, as a template for locating the tapped holes in the plate cavity. Fig. 4 shows the plate cavity rings mounted on the out-

put plate. Note that the inner ring is split to clear the rf output coupler.

The type-N output connector, which is made from a UG-58A chassis connector, is soldered in the 7/16-inch (11mm) hole on the output plate. The square mounting flange of the UG-58A is first cut off with a hack saw and then the barrel of the fitting is filed smooth. The mounting hole should be drilled under-size and reamed from the outside to provide a slightly tapered hole which will provide a force fit with the connector. When assembled, the Teflon part of the connector should be flush with the



Plate assembly before installation of the cathode cavity.

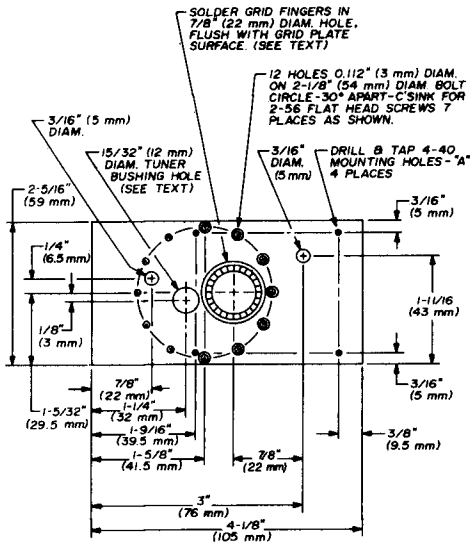

fig. 3. Grid partition for the 2304 amplifier. Material is 0.093" (2.5mm) brass.

inside surface of the output plate. Use a propane torch to provide sufficient heat for soldering. Bring the output plate up to temperature evenly, and avoid prolonged application of the flame directly on the type-N fitting.

The 15/32-inch (12mm) tuner bushing hole in the grid partition (fig. 3) should be drilled undersize, and reamed out to provide a force fit with the bushing. The tuner bushing (fig. 5), extending 1/8 inch (3mm) into the plate

cavity when pushed down against its shoulder.

Before soldering the grid finger stock and the tuner bushing to the grid partition, lay a 9x11-inch (23x28cm) sheet of fine emery cloth face up on a flat metal surface and sand the grid partition flat by moving the metal plate back and forth over the emery cloth. Then polish the surface of the plate with fine steel wool. The other plates should be treated in a similar manner.

The grid finger stock and the tuner bushing are soldered to the grid partition at the same time. The finger stock should be flush with the grid partition on the side facing into the plate cavity. When so located, the grid finger stock exerts a force which pulls the 2C39 into

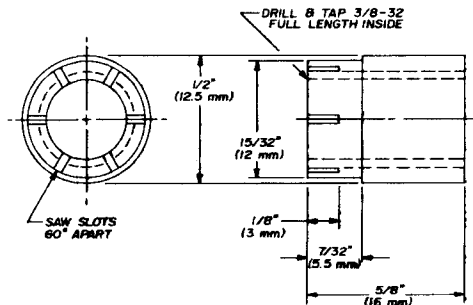

fig. 5. Tuner bushing (two required). Material is 1/2" (12.5mm) brass tube.

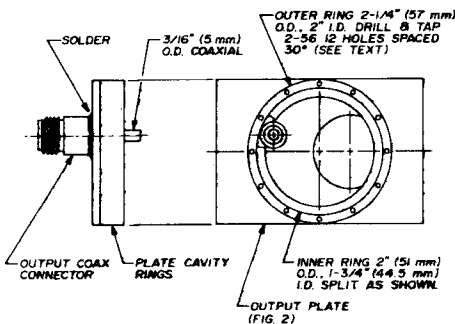

fig. 4. Plate circuit ring assembly (inside view on right).

position so that the surface of the grid next to the ceramic insulation of the tube is held against the grid partition. This is critically related to the resonance frequency of the plate cavity. To achieve proper grid finger stock position, lay the grid partition face down on a flat metal surface, insert the finger stock flush against the metal surface, and solder from the rear side using a propane torch.

Before drilling the 12 holes on the grid partition for the plate cavity, mount the plate cavity and the Teflon insulated plate ring to the output plate and insert

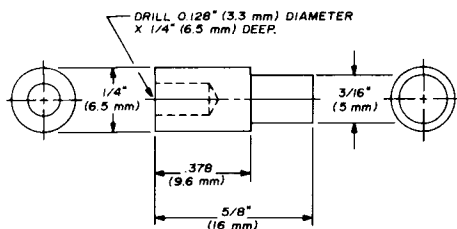

fig. 6. Coaxial couplers. Two are required, one for the input, the other for the output. Material is 1/4" (6.5 mm) brass rod.

the 2C39. Next, slip the grid partition into place, allowing the grid finger stock to hold the assembly together. Align the edges of the output plate and grid partition so they are parallel. Then, using a scribe, carefully mark the outer edge of the plate cavity on the inside of the grid partition. This will identify the exact position for the plate cavity and will help to properly locate the 12 mounting holes. This is an important step in fabrication since it is essential that the grid finger stock be perfectly aligned with the plate finger stock.

After drilling these 12 holes, reassemble the parts and mark the locations of the 12 holes on the plate cavity. Carefully drill and tap each hole approximately 3/16-inch (5mm) deep. Use 1/4-inch (6.5mm) long 2-56 stainless steel, binder-head screws to attach the grid partition to the cavity.

The 3/16-inch (5mm) hole in the grid partition is a clearance hole for the output coupler (fig. 6). The center

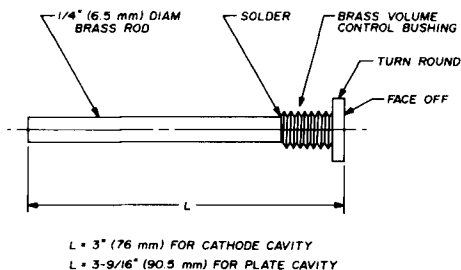
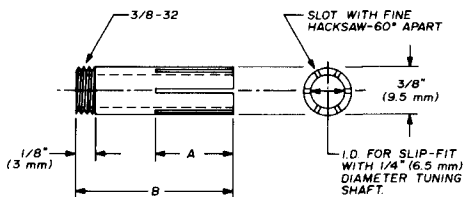

fig. 7. Tuning piston (two required).

conductor of the N connector is fitted with a 1/4-inch (6.5mm) diameter brass rod turned down on one end to 3/16 inch (5mm) to slip-fit into the 3/16-inch hole in the grid partition. The length of the 1/4-inch diameter portion of the coupler should be made a few thousandths of an inch longer than 3/8 inch (approximately 0.378" or 9.6mm) so its shoulder will bear against the grid partition wall when the amplifier is assembled. Before reassembling the output plate circuit, insert the tuning piston shaft (fig. 7) through the bushing from inside the cavity and thread the piston into place.



	A	B
PLATE SLEEVE	5/8" (16 mm)	1-1/4" (32 mm)
CATHODE SLEEVE	3/8" (9.5 mm)	3/4" (19 mm)

fig. 8. Tuning sleeves. One is required for each of the tuning pistons in the plate and cathode circuits. Material is threaded brass tubing (see text).

tuning pistons

The tuning pistons are made from 3/8-inch (9.5mm) brass bushings from old volume controls and 1/4-inch (6.5mm) brass rods. Insert the rod into the bushing as shown and solder the two together. Clamp an electric drill in a vise between two blocks of wood and mount the 1/4-inch (6.5mm) tuning piston shaft in the chuck. Then, using the hand drill as a lathe, file the hexagonal surface of the bushing round. Also, file the end of the assembly smooth and true.

The tuning pistons are screwed into the tuner bushing from inside of each

cavity. The tuning sleeves (fig. 8) are then slipped over the 1/4-inch (6.5mm) tuning shafts from the outside, and screwed into the tuner bushings. These sleeves provide the necessary mechanical stability and also serve as rf chokes for the tuning pistons; the amplifier should not be operated without them.

If brass tubing with 3/8-32 threads on the inside is not available, tap 13/32-inch (10.5mm) ID brass tubing to a depth of 5/16 inch (8mm) from each end as shown in fig. 5. Turn down the shoulder on one end by using your hand drill as a lathe. One of the tuning pistons can be used as a jig to hold the tuner bushing during this operation. The drill should be run at slow speed if a variable speed unit is available; otherwise, use a Variac to adjust the speed of the drill.

The discussion so far has been concerned with the plate circuit assembly. This assembly can now be temporarily laid aside while the cathode parts are assembled.

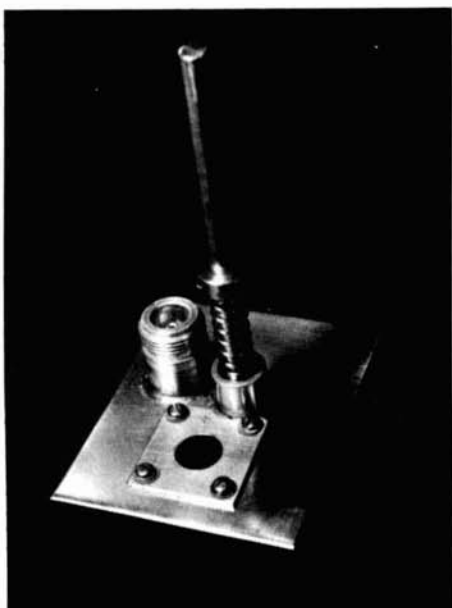

Fig. 12 is a cut-away view of the cathode assembly showing the cathode plate with its cavity, the type-N input connector and the piston tuning capacitor and tuning sleeve. The type-N connector and the tuner bushing are assembled and soldered in the same manner as described for the output plate. The input coaxial coupler is identical to the output coaxial coupler.

Fig. 10 is an outside view of the cathode partition. There are eleven 2-56 clearance holes located 30° apart on a 2-1/8 inch (54mm) diameter circle, three of which are countersunk to provide a flush surface for the heater/cathode assembly. These holes should not be drilled until later in the assembly.

The four C holes serve a dual purpose. They are primarily screwdriver clearance holes to facilitate the final assembly of the amplifier. However, they can also be used to attach support

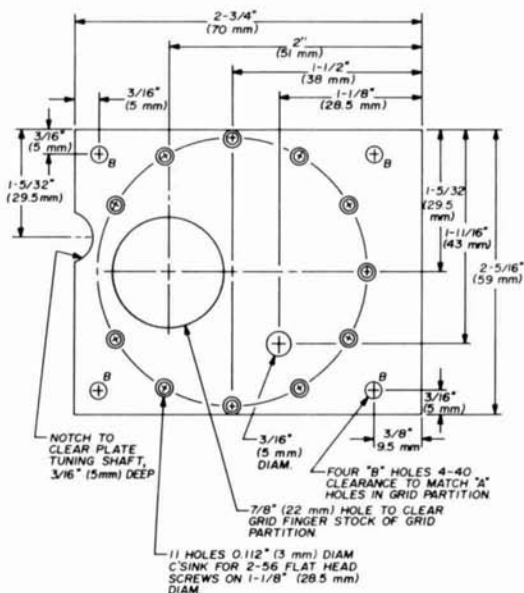
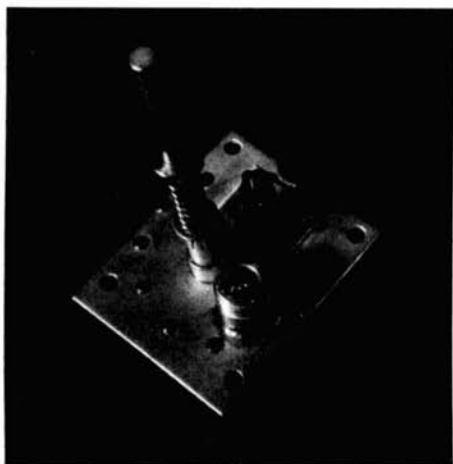

fig. 9. Grid cavity plate. Material is 0.093" (2.5mm) brass.



Front view of the cathode partition. Notch on rear edge provides clearance for plate tuning piston.

rods for mounting the amplifier to a panel.

cathode heater assembly

Parts from a surplus 2C39 amplifier were used for the heater-cathode assembly shown in fig. 11. The 7/32-inch (5.5mm) clearance hole at the center of the 1-inch (25.5mm) square plate is cut undersize and carefully reamed for a force fit over the heater-cathode assembly. It is important that a 2C39 be plugged into the heater cathode assembly during the reaming process, and also when the plate is soldered in position. Use solder sparingly so that it will not flow between the serrations and onto the 2C39 cathode sleeve. The location of the square plate is critical. Notch one side to clear the tuner bushing.

Before drilling the eleven clearance holes on the cathode partition for the 2-56 mounting screws, assemble the heater/cathode assembly to the cathode partition using shoulder washers and a 10 mil (0.25mm) Teflon insulating sheet. Use the heater-cathode assembly as a template for locating the four mounting

holes. Drill and tap these four holes for 2-56 screws. Then attach the cathode cavity to the grid cavity plate (fig. 9) using flat-head, 2-56 stainless-steel screws.

The plate circuit assembly should now be mated with the cathode assembly. Before this can be done a notch must be cut on the grid cavity plate to clear the plate tuning shaft. Next, lay the grid cavity plate face down on the outside of the grid partition and insert the 2C39 into the plate assembly socket. Then plug the cathode partition into the cathode end of the 2C39. If the instructions have been carefully followed, the face of the cathode plate will mate with the cathode cavity ring. If it does not, shim the heater-cathode assembly with a 1-inch (25.5mm) square, thin brass sheet with a central clearance hole and matching mounting holes.

Make sure that the sides of the cathode partition and grid cavity plate

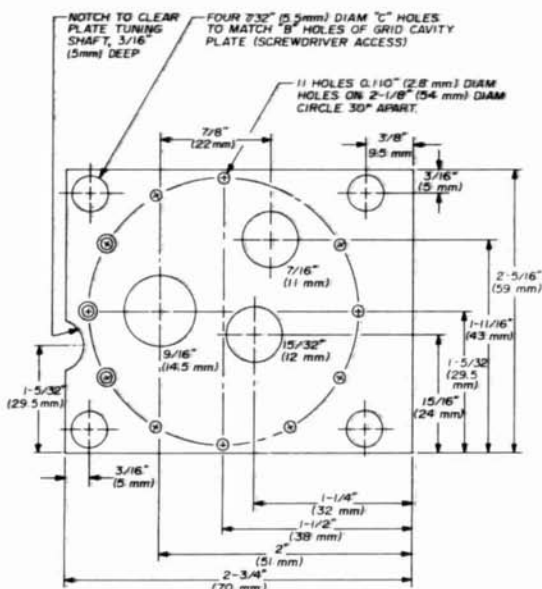

fig. 10. Cathode partition. Holes marked with letter C are screwdriver clearance holes to facilitate assembly. Material is 0.093" (2.5mm) brass.

are parallel and that they, in turn, are parallel with the sides of the plate assembly. Using a scribe, carefully mark the location of the cathode cavity on the cathode plate. This will help to locate the center of the 2-1/8 inch (54mm) diameter circle and the positions of the eleven cavity mounting holes. After these holes have been drilled, reassemble the parts and use the cathode partition as a template to locate the eleven 2-56 tapped holes on the cathode cavity.

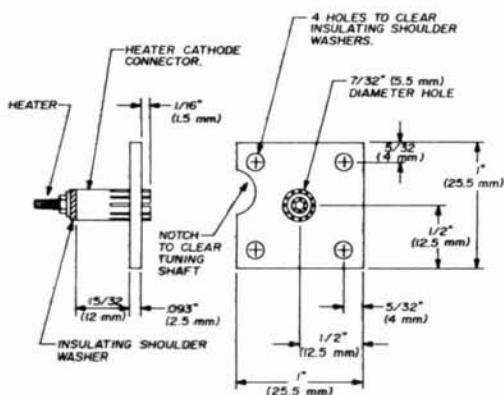

fig. 11. Heater/cathode assembly uses parts from surplus 2C39 amplifier. Material for the mounting plate is 0.093" (2.5mm) brass. Use the mounting plate as a template to locate four 2-56 tapped holes for assembly with the cathode partition.

Insert the 1/4-inch (6.5mm) shaft of the cathode tuning piston through the cathode tuner bushing from the inside of the cavity; then reassemble the cathode partition (fig. 10) with the cathode cavity assembly.

At this point the two major assemblies are complete. It is now only necessary to attach these assemblies together by threading four 4-40 screws through the B holes of the grid cavity plate into the four tapped A holes of the grid partition. A screwdriver can be slipped through the C holes to tighten these screws.



Inside view of the cathode partition and cavity assembly before it is attached to the plate assembly.

tune up

Check the insulation under the heater/cathode plate with an ohmmeter to make sure the filament and cathode are insulated from ground. Also, check the plate socket insulation. Wire the amplifier as shown in fig. 13. Start the tune up by applying a low voltage to the plate, or bring the plate voltage up slowly with the aid of a variable-voltage transformer.

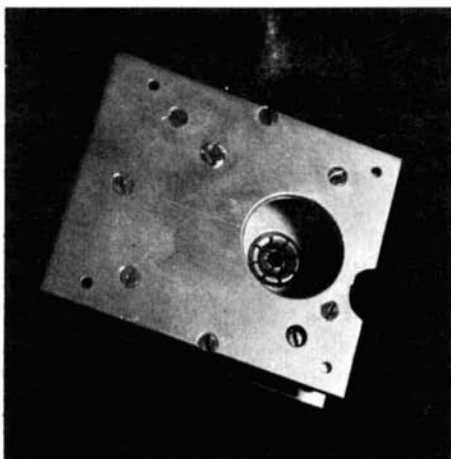

Bottom view of the cathode assembly.

The 50-ohm resistor in the cathode return circuit should be adjusted for a quiescent (no-drive) 2C39 plate current of approximately 40 mA with 1000 volts on the plate. With sufficient driving power, the plate current should reach approximately 120 mA. (If a 2C39 equipped with a water jacket is used,⁴ the plate current can safely be driven to 200 mA.) The 0-250 mA meter installed in the cathode circuit allows the grid current to be measured as the difference between the cathode and plate meter readings. Grid current levels over 50 mA may be reached.

I recommend the use of a 2304-MHz driver capable of providing about 5.0 watts output to compensate for losses associated with interconnecting cables and fittings. A 2C39 doubler, using a

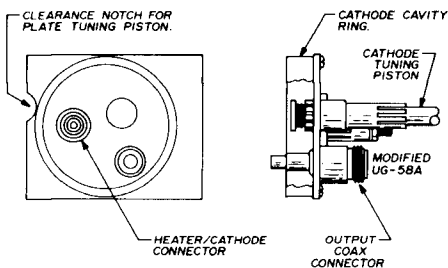

fig. 12. Inside view (left) and cutaway view (right) of the cathode assembly, showing location of the various components.

plate circuit identical to the one described here, will easily provide 5 watts of drive power. With 5 watts of drive the rf power output from the amplifier should be between 20 and 40 watts, depending on the particular 2C39 used in the circuit.*

Surprisingly, the power gain of most 2C39s tried in this circuit measured

*A Hewlett-Packard 434A Colorimetric Power Meter was used in conjunction with a 2- to 4-GHz Narda 10-dB coaxial directional coupler for making power measurements.

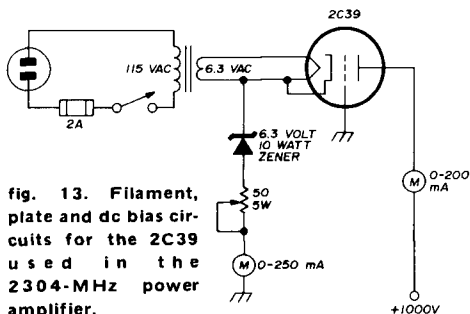

fig. 13. Filament, plate and dc bias circuits for the 2C39 used in the 2304-MHz power amplifier.

about 13 dB. A hot 2C39 may deliver over 30 watts CW output with only 1.5 watts drive. Plate circuit efficiencies run between 20 and 25%. Typical operating conditions with air cooling may be 130 watts dc plate power input and 30 watts rf output. The 2C39 plate dissipation would then be 100 watts and the efficiency 25%.

If water cooling is used, over 40 watts rf output can be obtained for 200 watts dc plate input. With air cooling, 15 seconds or more may be required before full power output is achieved once the amplifier has been previously tuned up hot. With water cooling the key-down operating temperature is much less than for air-cooling, and full power output is achieved within a few seconds after plate power is applied.

By following the instructions given in this article, you can generate relatively large amounts of rf power on 2304 MHz. Now, who has a good 2304-MHz eight-tube ring-amplifier design?

references

1. Peter Laakmann, "Cavity Amplifier for 1926 MHz," *QST*, January, 1968, page 17.
2. R. Fisher, W2CQH, C. Schaible, W2CCY, G. Schober, W2OJ, and R. Turrin, W2IMU, "1296-MHz Power Amplifier," *ham radio*, March, 1970, page 43.
3. Peter Laakmann, "High-Power Linear for 1926 MHz," *ham radio*, August, 1968, page 8.
4. Mike Staal, K6MYC, "Watercooling the 2C39," *ham radio*, June, 1969, page 30.

ham radio

NOW.
Top-of-the-Line
Tri-Ex Towers
for HAM operators
at basic prices!

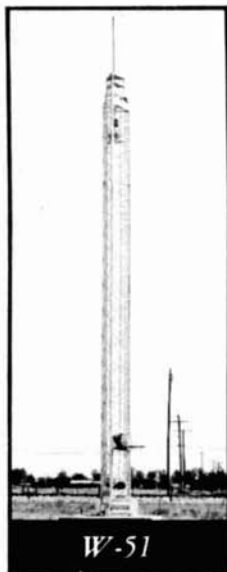

W-51

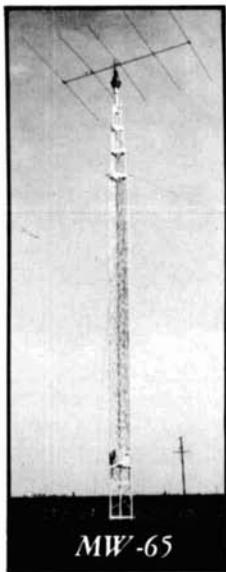

MW-65

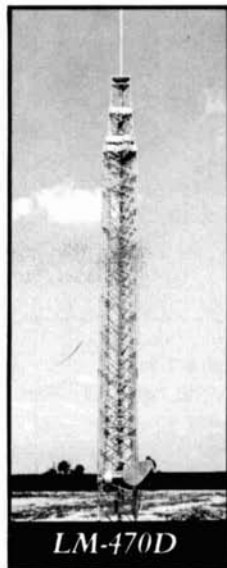

LM-470D

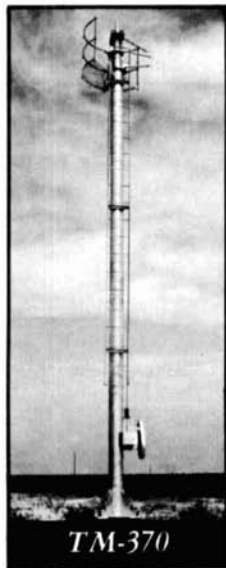

TM-370

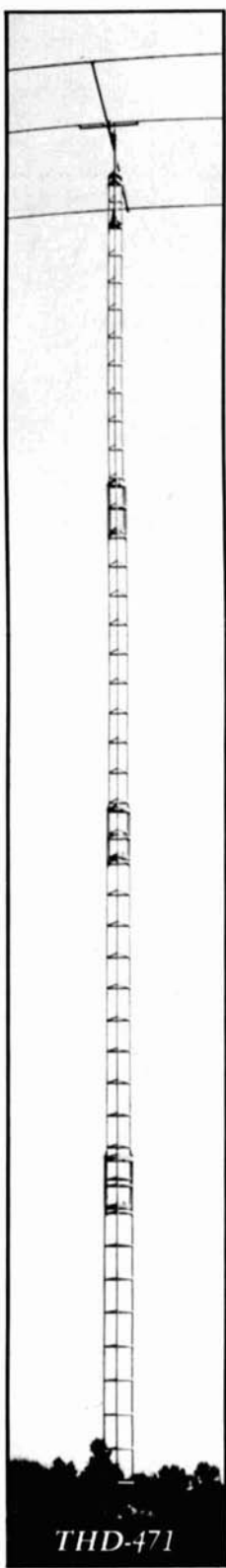

THD-471

Now you can afford the best! Free-standing or guyed, Tri-Ex Towers stress quality. All towers are hot dipped galvanized *after* fabrication for longer life. Each series is specifically engineered to HAM operator requirements.

W Series

An aerodynamic tower designed to hold 9 square feet in a 50 mph wind. Six models at different heights.

MW Series

Self-supporting when attached at first section — will hold normal Tri-Band beam. Six models.

LM Series

A 'W' brace motorized tower. Holds large antenna loads up to 70 feet high. Super buy.

TM Series

Features tubular construction for really big antenna loads. Up to 100 feet. Free-standing, with motors to raise and lower.

THD Series

Very popular. Low Cost. Holds Tri-Band antennas. Eight models — all support 7 square feet of antenna at full height in 70 mph winds. Guyed.

Start with Top-of-the-Line Tri-Ex Towers. At basic prices. Write today, for your best buy.

ri-Ex[®]
TOWER CORPORATION
 7182 Rasmussen Ave.
 Visalia, Calif. 93277

bandpass filters

for receiver preselectors

Design and
construction details
for bandpass filters
suitable for many
amateur applications

Wes Hayward, W7ZO1, 7700 SW Danielle Avenue, Beaverton, Oregon 97005

There was a time when the capabilities of an amateur receiver were well summarized by specifying its selectivity, sensitivity and stability. While the specifications offered by the manufacturers of our present-day receivers rarely include much more, the parameters of significance to a critical operator on the high-frequency bands also include the blocking level, intermodulation levels and sensitivity to cross modulation.

A severe test of an amateur receiver is during contest operation when a large number of signals are present, many of them quite strong. Undoubtedly the most extreme conditions are presented during the ARRL Field Day when the operator must fight not only extensive QRM present on most of the bands, but must also contend with other transmitters operating from his own location, often separated only a few hundred kHz from his own frequency. Designing a receiving system to survive such an environment is one of the most exciting and challenging problems presented to the devoted contest operator.

The solution to large-signal problems lies in the design of the receiver front-end. Great care must be used in determining a proper gain distribution. Further, the proper active devices must

be carefully applied to realize an optimum dynamic range. Along with these requirements, the receiver must be protected from out-of-band signals as much as possible. This latter requirement is met with carefully designed preselection filters and forms the basis for this article. Clearly the design of bandpass filters is applicable to many areas other than receiver preselection.

As with most areas of interest to the technically inclined radio amateur, the preselector synthesis problem can be approached from both a theoretical and an experimental point of view. In this article I will attempt to emphasize the empirical approach. However, any experimental activities are markedly enhanced by an understanding of the basic principles. To this end, some of the fundamentals of filter design will be discussed. Some practical designs are also presented for duplication by the experimenter, if desired.

In a recent article by Nagle,¹ the design of bandpass filters was presented using the classic lowpass to bandpass transformation. While this technique is extremely useful for many design problems, it is generally limited to filters with wider bandwidths. When you attempt to build filters of only a few percent bandwidth, you find that the results are often inconsistent with the classic image-parameter designs. The reason for this is that the experimental results are "distorted" by the finite unloaded Q of the tuned circuits used in the filter. Hence, a more meaningful theoretical approach is to use "pre-distorted" design tables which allow the designer to account for the unloaded Q

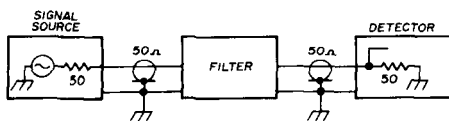

fig. 1. Basic test set-up for aligning and evaluating filters.

of the resonators on hand. The term "resonator" is used in preference to the more usual "tuned circuit" since the methods are applicable to systems at all frequencies from audio to the microwave region.

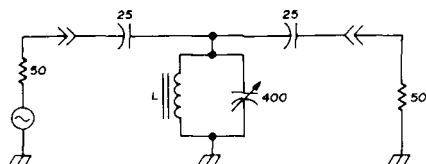

fig. 2. Single resonator filter for operation at 7 MHz. The inductor, L, is 1.3 μ H, consisting of 17 turns number-22 wire on an Amidon T-68-6 toroid core; unloaded Q of the inductor is 275. Response of this filter is plotted in fig. 6.

measurement techniques

Shown in fig. 1 is a generalized block diagram of the test set-up which should be used for the alignment and evaluation of preselector filters. There are three basic parts to the system: a signal source, the filter being tested and a calibrated detector. There are a number of pieces of equipment which could be used for both the signal source and for the detector, depending upon the gear available in your own lab.

One suitable signal source would be one of the many inexpensive signal generators on the market such as the Heath IG-102. However, it is quite important that the output impedance of the source be constant and known, typically 50 ohms. This is rarely the case with inexpensive signal generators. This problem is easily solved by inserting a 10-dB attenuator between the generator and coax leading to the filter. Similarly, a vfo-controlled low-power transmitter covering the frequency range of interest would be suitable if it is used with a 10-dB pad.

Although high-frequency oscillo-

scopes, wide-range spectrum analyzers or even a QRP power meter² are all suitable as detectors, probably the most commonly available item is your station receiver. As with the generator, it is quite important that the input impedance of the detector be 50 ohms, rarely the case with receivers. Again, a 10-dB pad at the input to the receiver is a suitable solution. If you have great faith in your receiver's S-meter, you can use it as the output indicator. A much safer method would be to precede the receiver with a step attenuator and

measurements presented in this article were obtained with an HP-8640B Signal Generator and a Tektronix 7L13 Spectrum Analyzer, used as a detector. However, all alignment and initial evaluation was done with the less exotic gear available in my home workshop.

the single tuned circuit

As an initial step in our investigation of filters, let's take a look at the common, single resonator. While this configuration is hardly profound, it is typical of the minimal preselection found in most of our amateur receivers. Secondly, many of the conclusions you reach in pursuing such a simple system are qualitatively very general and can be applied in building more elaborate, multi-resonator filters.

For our design example, the resonator shown in **fig. 2** will be considered. The coil is merely 17 turns of number-22 enamelled wire on an Amidon T-68-6 toroid core. This will be resonated at 7 MHz with a 400-pF mica compression trimmer capacitor. The unloaded Q of this inductor was measured as 275. As will be shown, a laboratory Q-meter is not necessary for this measurement. Energy is coupled into and out of this resonator with a pair of 25-pF capacitors. In all analysis, always assume that the filter is driven and terminated by 50-ohm resistive sources.

To analyze this circuit, one more element is needed: Some means for modeling the Q of the inductor. This is shown in **fig. 3**. As is well known, the finite Q of any lumped tuned circuit can be represented by either a series or parallel resistance connected to ideal inductors and capacitors. For our application the parallel representation is more useful and yields $R_p = 15700$ ohms.

Although I will not go through the details, the resonator is easily analyzed using classic ac circuit theory.⁴ First, it can be shown that the 25-pF coupling capacitors have the effect of transform-

$$Q = \frac{R_p}{X_L} = \frac{F_o}{BW_{3dB}}$$

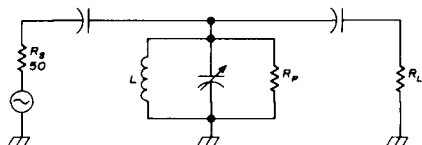

fig. 3. Equivalent circuit for modeling the Q of the inductor used in the circuit of **fig. 4** (see text).

monitor the receiver output with an audio voltmeter. Since all measurements will be done with the attenuator using the substitution technique, the audio voltmeter does not need to be calibrated. The attenuators described by Daughters and Alexander³ are very inexpensive, easy to build, and usable into the vhf spectrum.

The test equipment I use is variable, but typically starts with a homebrew signal generator with about 4-milliwatts output. This output is split, with one component feeding a frequency counter; the other output feeds an attenuation pad which then drives the filter under test. The output of the filter drives a step attenuator which drives a broadband amplifier. This, in turn, is applied to a square-law detector using a hot-carrier diode. The system is suitable for measurements over a range greater than 50 dB at frequencies up to the low end of the vhf spectrum. All measure-

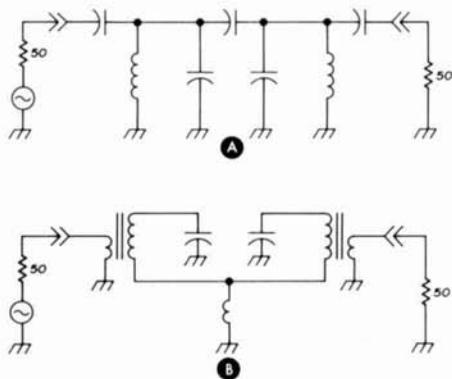

fig. 4. Two forms of the double-tuned resonator. Capacitive coupling is used in (A); inductive coupling is used in (B). Performance of both circuits is identical.

ing the 50-ohm source and load to parallel equivalents. In this case, the series 50-ohm resistor and 25-pF capacitor transforms to a parallel resistance of 16.6 kilohms in parallel with a capacitance just under 25 pF. The net load across the resonator is now the parallel combination of the two 16.6-kilohm external loads and the 15.7-kilohm resistor representing the inductor losses, or, in this case, 5.5 kilohms. Using the equation in fig. 3 which

relates Q to parallel load resistance, the loaded Q is calculated to be 95. Additional arithmetic will show that this filter has a bandwidth of 74 kHz and insertion loss of 3.7 dB.

The data on this resonator become more enlightening as you consider some other component values. For example, if you change the input and output coupling capacitors to 10 pF, the loaded Q goes up to 210, yielding a filter with a bandwidth of 33 kHz, but with an insertion loss of 12.5 dB. If you use 50-pF input and output capacitors, you realize a filter with a Q of 32, bandwidth of 220 kHz and insertion loss of only 1.1 dB.

Probably the most significant conclusion is that insertion loss *must* increase as you go to narrower bandwidths. For the single tuned circuit it can be shown that the loss is given by

$$\text{Insertion loss} = -10 \log_{10} \left(1 - \frac{Q_L}{Q_U} \right)^2 \text{ dB}$$

From the equation you see that filters with low insertion loss can be realized only by using resonators with a very high unloaded Q , or by accepting a wider bandwidth (i.e., reduced loaded Q).

While all of this may seem to be

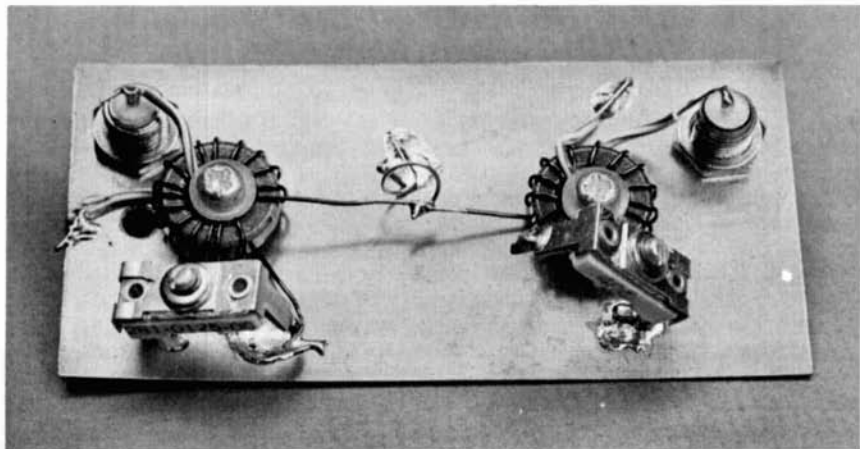

fig. 5. Two-section, double-tuned filter for use on 7 MHz. Measured response of this filter is plotted in fig. 6.

quite basic and perhaps academic, it is quite significant, for it allows you to make measurements which will tell you a lot about your filter. For example, if you measure the bandwidth and the insertion loss of the filter shown in **fig. 2**, you can then calculate the unloaded Q of the resonator. Alternately, if you use a 1-pF capacitor to lightly couple to

sarily matched in the classic sense of maximizing power transfer. Similarly, if the input impedance of a receiver is specified as being 50 ohms, this means that the unit should be driven from a 50-ohm source. However, the impedance which would be seen by a bridge looking at the input may be something quite different.

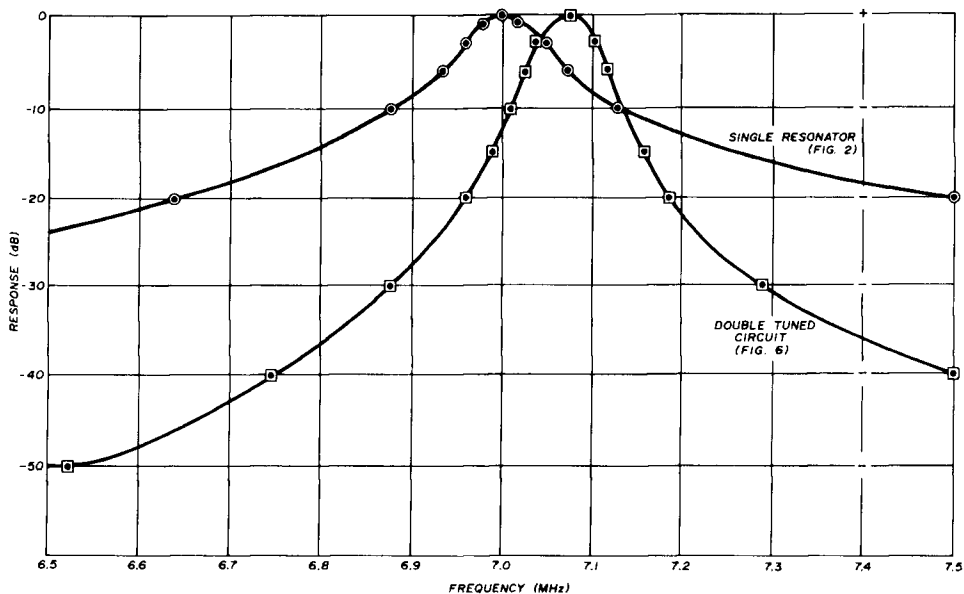

fig. 6. Measured frequency response of the single- and double-tuned 7-MHz filters.

the load and the source, the insertion loss will be 46 dB, but the measured Q will be within 1% of the unloaded Q of the system. This method of Q measurement is straightforward, and applicable at frequencies well outside the range of the typical Q-meter.

Before progressing to the double-tuned circuit, there are a couple more calculations which are enlightening. If you disconnect the generator but leave the output terminated in 50 ohms, the input resistance seen at the input to the filter is about 102 ohms, and not the 50 ohms you might expect. When working with filters, impedances are not neces-

In the example of **fig. 2** series capacitors have been used to transform the generator and termination to resistances useful for loading the filter. However, the more common, and often more convenient, method is to use link coupling. Toroid cores have as one of their virtues the asset that impedances transform as the square of the turns ratio. Assume, for example, that a three-turn link were placed on the 17-turn coil and that the link is terminated in 50 ohms. The effective resistance across the coil is thus

$$50 \left(\frac{17}{3} \right)^2 = 1606 \text{ ohms}$$

This is, of course, in parallel with any other loads which may be present, including the resistance representing the unloaded Q of the resonator.

the double-tuned circuit

Shown in **fig. 4** are two forms of the double-tuned circuit. Although a bit

capacitive coupling should be used between resonators.

Consider an empirical approach to designing a two-resonator filter. The first step is to choose suitable components. Generally, the only criterion of significance is that the unloaded Q be as high as possible. If capacitive coupling between resonators is to be used, it is

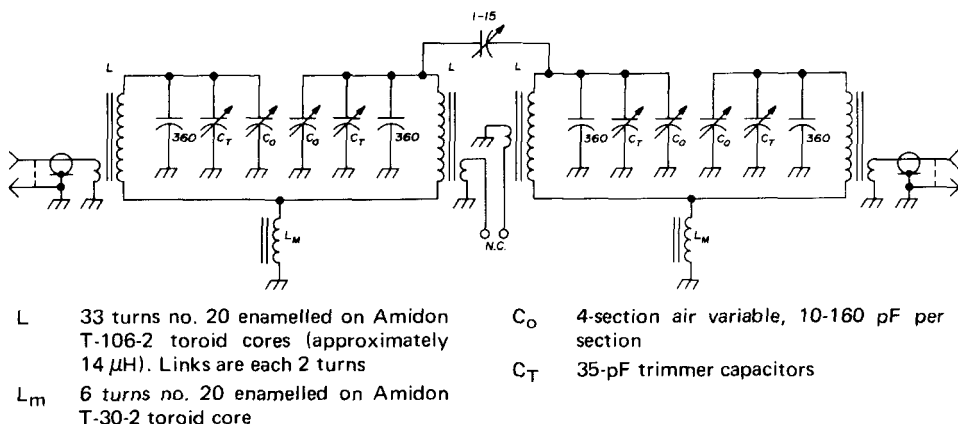

fig. 7. Four-resonator filter designed for the amateur 160-meter band. Measured response of this filter is plotted in **fig. 9**.

more complicated than the single resonator, it has the property that steeper skirts can be realized while maintaining a wider 3-dB bandwidth. As might be expected, you must pay the price of higher insertion loss to realize these assets.

Fig. 4A shows a capacitor for coupling between resonators as well as capacitive coupling to the external load. **Fig. 4B** shows the use of inductive coupling. For fixed-tuned filters the two methods, or mixtures of the techniques such as link loading with capacitive coupling between resonators, are virtually equivalent. However, if the filters are to be tuned over some band of frequencies, a little more care should be taken. If, for example, a dual-section variable capacitor is to be used, the scheme of **fig. 4B** should be used. If inductive tracking is to be used (*à la Collins receivers*), then

generally advisable to lean toward lower L to C ratios in the basic resonator since this makes adjustment a little easier. Once the resonators are chosen, each resonator is loaded lightly and equally and the two resonators are coupled lightly. The generator is set at the desired center frequency and the system is tuned to resonance. The insertion loss is measured and then the generator is tuned over the range of interest. A single peak is typically noted.

If the bandwidth is too narrow and/or the insertion loss is higher than acceptable, the coupling between resonators is increased until the passband response begins to appear flat. If the coupling is increased further, a double-humped response will be noted and the insertion loss at the center of the filter will increase. At this point, the loading of the two sections must be increased,

the filter re-resonated at the passband center and the coupling adjusted for a fairly flat response. For the class of filters considered in this article it is important to keep the loading equal on each section. This general procedure is continued until the desired bandwidth is

7.5 dB, an acceptable figure for typical 40-meter work. However, this much insertion loss would be clearly intolerable on the vhf bands, or even on 10 meters.

There is a slightly more formal, but extremely useful, method for adjusting

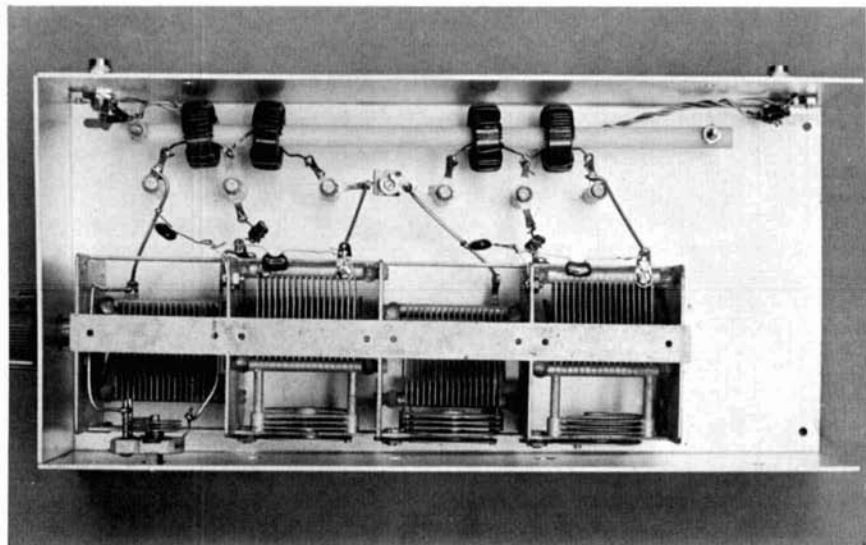

fig. 8. Construction of the four-resonator 160-meter filter shown in fig. 7.

obtained, always remembering that there is going to be a tradeoff between bandwidth and insertion loss.

Shown in fig. 5 is a photograph of a two-section, 40-meter filter which was built in this manner. A pair of the 17-turn toroids discussed earlier were used with a 400-pF compression trimmer for tuning. Loading was accomplished with one-turn links. A mutual inductor was used for coupling between resonators. The coupling inductor was one turn, about ¼-inch (6-mm) long and ¼-inch (6-mm) in diameter. Shown in fig. 6 are the measured responses of the single-resonator (fig. 2) and double-resonator filters. The superior skirt response of the two-resonator system is obvious. The insertion loss of the double-tuned system was measured at

a two-section, equally-loaded filter. In the earlier discussion of the single-resonator filter it was noted for the 7-MHz filter that very light loading occurs as you couple into the system with 1-pF capacitors. This was used to advantage in measuring unloaded Q. This light "probing" of a resonator is also used in this filter tuning technique.

In a two-section filter designate the resonator driven by the generator as resonator A; resonator B is connected to the load. The two resonators are assumed to be identical. The following tuning procedure is followed:

1. Resonator B is shorted at the hot end. The generator and detector are each lightly coupled (i.e., 1-pF capacitors) in an identical fashion to resonator

A. This resonator is tuned for resonance at the center frequency and the couplings to the generator and load are checked for at least 30-dB of insertion loss.

2. The ultimate design bandwidth is picked and designated as BW. The coupling element between resonators A and B is arbitrarily adjusted to some level and resonator A is re-trimmed for a peak response.

3. While still lightly exciting at the center frequency and probing resonator A, resonator B is unshorted and tuned to resonance. This is detected as a large dip in output in the detector, often as much as 30 dB in tightly coupled, high-Q resonators.

4. Now, the generator is detuned from the center frequency of the filter. As the generator is swept through the range of interest, two strong peaks will appear in resonator A. These frequencies are noted.

5. Steps 2 through 4 are repeated with different adjustment of the coupling between resonators A and B. The coupling is correct when the frequency separation between the peaks (step 4) is $BW \times 0.707$.

6. Now, resonator B is again temporarily shorted. The detector is left coupled very lightly to resonator A. However, the generator is tightly coupled to the 50-ohm generator. Resonator A is tuned for a peak response at the center frequency and the loaded 3-dB bandwidth is measured by sweeping the generator.

7. Step 6 is repeated while adjusting the loading until the loaded bandwidth of resonator A equals $0.707 BW$.

8. The detector is now lightly coupled to resonator B and resonator A is shorted. Resonator B is tightly coupled to the generator and the loading adjusted as in steps 6 and 7 for a loaded bandwidth of $0.707 BW$.

The filter is now tuned. While this method sounds a bit cumbersome, it's really much easier to do than it is to describe. The resulting filter will have something close to a two-pole Butterworth response. As a general rule-of-thumb, the insertion loss will be around

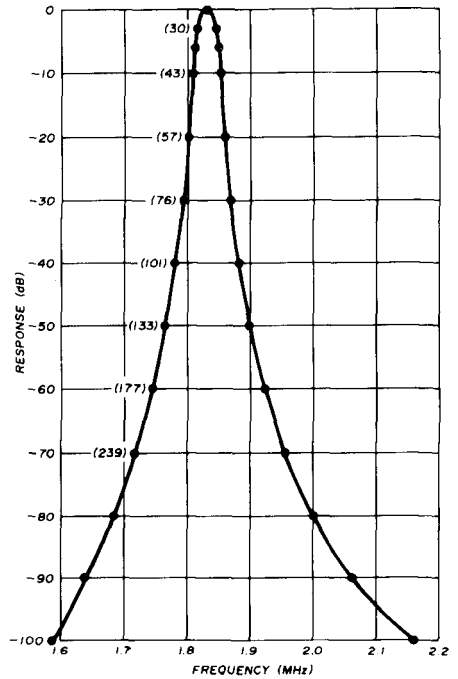

fig. 9. Measured frequency response of the four-resonator 160-meter filter shown schematically in fig. 7.

4 dB if the design bandwidth is four times the unloaded bandwidth of the resonators chosen. Decreasing the bandwidth to just twice the unloaded resonator bandwidth will increase the insertion loss to around 10 dB. If the coupling between resonators is made a bit tighter and the ends of the filter are loaded lighter, a Chebyshev response results. This will steepen the skirt response at the expense of additional insertion loss.

four-section design examples

As you progress to filters with more

than two sections, the problems also increase. As expected, the insertion loss increases as the number of resonators goes up. However, the skirt response also becomes better. In many receiver applications, the noise figure degradation resulting from a higher insertion loss makes one shy away from filters which are overly exotic. A better approach is often to place a low-gain amplifier between a pair of double-tuned circuits.⁵

One empirical approach to the design of a four-pole filter is illustrated in the circuit of **fig. 7**. This unit was built for use at W7RM on the 160-meter band.

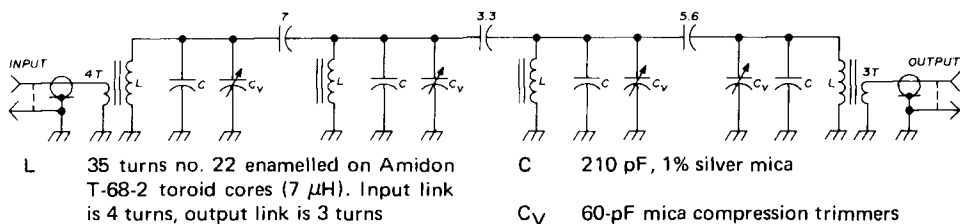

fig. 10. Four resonator filter for use on 80 meters has 100-kHz bandwidth, 4.4-dB insertion loss and 6- to 60-dB shape factor of 5.16. Response is plotted in **fig. 11**.

The filter is tunable from 1.8 to 2.0 MHz and has an insertion loss of 5 dB. The 3-dB bandwidth is 30 kHz and the 6- to 60-dB shape factor is 4.78. Stop-band attenuation is more than 120 dB.

The key to the performance of this filter is the high-Q toroid cores chosen for the resonators. Amidon T-106-2 toroids were used since they exhibit an unloaded Q of 330 at 1.8 MHz, a feat difficult to achieve with air-core coils of any reasonable size. Incidentally, I have found the Q and inductance data supplied by Amidon* to be quite reliable and repeatable.

The filter was built by first constructing two identical double-tuned circuits. They were each adjusted for about 2-dB insertion loss with 50-ohm

terminations at each end. Then the two filters were capacitively coupled through a small air trimmer. Final adjustment was done by trimming the frequency of the resonators and the coupling capacitor for optimum pass-band shape. The fact that one capacitive coupling element was used in a system with capacitive tracking led to a 1-dB variation in insertion loss as the filter is tuned over the band. Also, it was found necessary to adjust the turns spacing on some of the coils in order to implement tracking.

The Top-Band filter is shown in the photograph, **fig. 8**. The resistors near

the BNC coax connectors are 3-dB pads which were inserted to insure that the filter termination is always fairly close to being correct. This is often a problem on the 160-meter band where split frequency operation is used. Shown in **fig. 9** is the measured response of the filter when tuned to the European 160-meter "window" at 1830 kHz.

Presented in **figs. 10** and **11** is data for a filter for the 80-meter band. This filter was designed using the pre-distorted design data presented in Zverev,⁶ assuming an unloaded resonator Q of 225. The measured insertion loss of 4.4 dB was slightly under that predicted, indicating that the unloaded Qs were a bit higher. Otherwise, the results are very close to the desired Butterworth design. Although the filter was designed and aligned at 3750-kHz, re-alignment at 3600 and 3900 yielded similar

*Amidon Associates, 12033 Otsego Street, North Hollywood, California 91607.

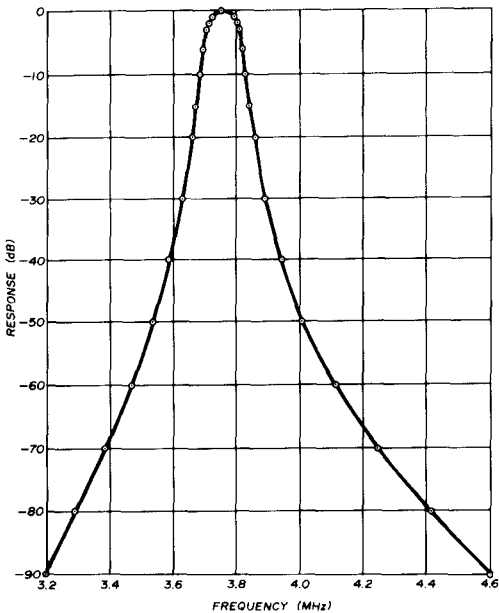

fig. 11. Measured frequency response of the four-resonator 80-meter filter shown in fig. 10.

results. To fit the design exactly as the center frequency is changed, the coupling capacitors between the resonators should be directly proportional to the total tuning capacitance in each resonator.

The synthesis of multipole filters of narrower bandwidths or at higher frequencies becomes more difficult. The four-pole 80-meter filter described above had a bandwidth of about six times the unloaded bandwidth of the resonators, consistent with an insertion loss of a little over 4 dB. If a sharper filter is required, the only solutions are to accept much higher insertion losses,

*A helical resonator has been described in the amateur literature as a coil surrounded by a shield. A more accurate description is that the helical resonator is a quarter-wavelength of special helical transmission line. This line is similar to coax except that the inner conductor is helically wound, yielding a very low axial propagation velocity. Hence, an electrical quarter-wavelength will be much shorter than an equivalent coaxial resonator.

or to use resonators with much higher unloaded Q.

Myers and Greene⁷ have reported on the construction of helical resonators* for the high-frequency region. For example, a two-section filter was described using resonators capable of yielding an unloaded Q of 700 at 7 MHz. With such resonators a double-tuned circuit at 40 meters would yield a 4-dB insertion loss with a bandwidth of 40 kHz. When tuned in the CW segment of the band there should be more than 30-dB attenuation over most of the 40-meter phone band. If proper input-output isolation is maintained in such a filter, the attenuation to even-order, harmonically-related bands should be well over 60 dB. While such performance will do wonders for the typical Field-Day installation, proper filter adjustment is mandatory.

Oddly, the basic problems become a little less difficult as you move into the vhf region for it is easier to build high-Q resonators. The procedures are essentially the same as those described, although the systems may look much different physically. The single, most important concept to remember at any frequency is that the price of narrow bandwidth must be paid in insertion loss.

references

1. John Nagle, K4KJ, "Bandpass Filter Design," *ham radio*, December, 1973, page 36.
2. Adrian Weiss, K8EEG, "Simple RF Power Meter," *ham radio*, October, 1973, page 26.
3. George Daughters, WB6AIG, and Will Alexander, WA6RDZ, "Homebrew Step Attenuators," *73 Magazine*, January, 1967, page 40.
4. Hugh H. Skilling, *Electrical Engineering Circuits*, John Wiley & Sons, New York, 1957.
5. Wes Hayward, W7ZOI, "A Competition-Grade CW Receiver," *QST*, March, 1974, page 16; April, 1974, page 34.
6. Anatol I. Zverev, *Handbook of Filter Synthesis*, John Wiley & Sons, New York, 1967.
7. Robert Myers, W1FBY, and Clarke Greene, WA1JLD, "Field Day Filters," *QST*, April, 1973, page 18.

ham radio

principles of speech processing

A discussion of
the various
speech processing systems,
and some suggestions
for further
experimentation

Although there is a great deal of interest at present in developing practical speech processing systems to increase the effectiveness of radio transmitters, the basic principles and problems have been understood since the 1920s.^{1,2} First of all, most speech falls within a frequency band of a little over three octaves around the range from 300 to 3,000 Hz, and most of the speech energy is concentrated in the lower octave of the range. These lower-frequency sounds contribute to the individual timbre of the voice but have little to do with the intelligibility of speech. Furthermore, most speech intelligence is carried in the band around 1 kHz in most voices. Most ears are most sensitive around this band, too.

Speech has a high ratio of peak-to-average energy. The peaks may be clipped until the speech envelope ap-

proaches a series of square waves at clipping levels around 30 dB, where speech is still readily intelligible although unnatural sounding. Due to the wide range of individual voice characteristics, languages and dialects used there is no agreed index of intelligibility,² and optimal speech processing systems must be tailored to the individual voice.

Practical speech processors are designed to take advantage of all or some of these facts. In communications practice the designer is prepared to sacrifice voice fidelity for increased communication effectiveness, but it should be kept in mind that very subtle processing techniques are part of the normal practice in recording and broadcasting studios where the object is to keep maximum fidelity of sound within the limits of the transmission medium. These systems are well worth study by anybody developing communications speech processors.

frequency shaping

Since most of the speech energy is concentrated in the lower part of the voice frequency range and contributes little to the transmitted intelligence, it follows that an immediate increase in the transmitter effectiveness will result by ensuring that the transmitter speech amplifier has a falling bass response. The higher-frequency speech components above 2.5 kHz contain little energy or intelligence and are normally restricted in communications systems to reduce the transmission bandwidth. In ssb transmitters the extreme high and low

Barry Kirkwood, ZL1BN, Department of Psychology, University of Auckland, New Zealand

voice components are usually attenuated by the sideband filter. Moreover, communications microphones are generally designed to emphasize the essential mid-range voice frequencies. Nevertheless, some advantage can be expected by designing the speech amplifier so that it has a frequency response similar to that shown in fig. 1 where the slope is 12-dB per octave below the knee point at 1.1 kHz.³

Good results are also reported by Schmitzer^{4,5} using a speech processor with a preamplifier having a passband resembling fig. 1 with a slope of 6-dB per octave below 2 kHz, increasing to 12-dB per octave below 300 Hz.

It is impossible to predict the increase in effective communication power due to frequency shaping alone since individual voices vary, but it is safe to say that the advantage will increase in proportion to the deepness of the voice and the bass response of the microphone. Subsidiary advantages include a reduction in ac supply hum and other low-frequency noise which become a severe problem when high levels of

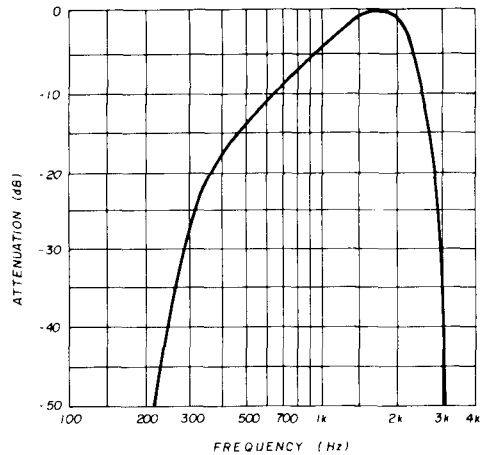

fig. 1. Frequency response of a speech processor with 12-dB per octave rolloff below 1.4 kHz and sharp rolloff above 2 kHz.³

compression or clipping are used following the microphone amplifier.

Listening to transmissions on the air leads one to believe that many signals would have improved intelligibility if the size of the coupling capacitors in the speech amplifiers were reduced, a simple and inexpensive modification.

There is room for experiment in even more radical shaping of the audio bandpass. For example, it's possible that the introduction of a slot into the audio bandpass in the region of 700 Hz, so as to split the band into two parts as shown in fig. 2, would permit a gain in intelligibility for a given power. By juggling the output of the upper and lower channels the best trade between intelligibility and naturalness for a particular voice and style of operation should be possible. How wide or deep the slot should be made (or if it should be made at all) is a matter for urgent experiment.

Frequency shaping alone will give advantage in any form of voice transmission, but speech pre-emphasis becomes imperative if any form of compression or amplitude limiting (clipping) is used in the system. In fact, any device

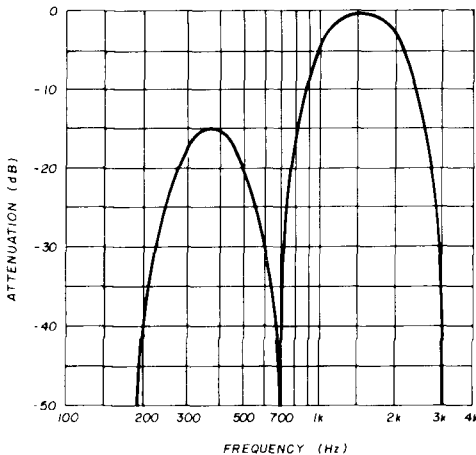

fig. 2. Frequency response of an amplifier that places a notch between the lower and middle speech bands. Theoretically this should give improved intelligibility, especially if the two channels are independently clipped and then summed together.

of this type that does not use pre-emphasis is failing to make the best use of its possibilities and demonstrates a lack of understanding of the principles outlined in the first paragraph of this article.

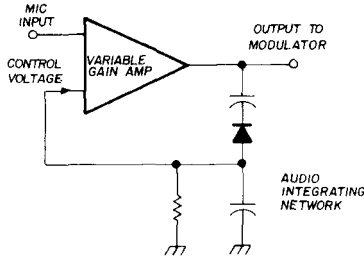

fig. 3. Block diagram of a simple audio compressor.

dynamic compression

Since the amplitude of the energy peaks in speech are much higher than the average energy level, and we know that reducing this dynamic range has little effect on intelligibility within wide limits, it follows that some increase in effective communications power should be possible by applying automatic gain control (agc) to the audio amplifier section of your ssb transmitter. All dynamic compressors work by feeding back a control voltage from some later stage of the system so that gain is varied in such a way that the output level is held more or less constant.

The automatic level control (alc) used in many ssb transmitters functions as a dynamic compressor. Many of these systems work by taking a small control voltage from the grid circuit of AB1 tetrodes which is developed as the tubes run into grid current. Thus, as the tubes are pushed into AB2, the speech envelope of the ssb signal is rectified and fed back to an earlier amplifier, reducing its gain, tending to compress the transmitter output. Many amateurs run their transmitters well into alc and thus have a certain level of compression without

realizing it. When additional speech processing is added to the system the result may not be as good as expected since the system is already providing some compression.

Running such transmitters into alc is a questionable practice. No figures on intermodulation products emitted by equipment as it runs into alc seem to be available. The distortion level on the verge of AB2 operation need not necessarily be high so long as certain design considerations are met: notably low impedance and good regulation in the grid bias system. But most alc systems run by virtue of having a considerable impedance in the grid circuit over which the alc voltage is developed and there is likely to be a sudden rise in splatter products as alc operates.

Audio compressors acting on the agc principle have been critically discussed elsewhere^{5,6} and many practical designs have been described.^{7,8,9} With sophisticated designs intelligibility in noise may be increased up to about 4 dB. The chief disadvantage of simple compressors is that in the intervals between words the gain rises and, thus, background noise appears to rise. Tailoring the time constants in the agc loop cannot give a very high modulation index: if the time constant is fast enough to follow the fast speech sounds then the system is pushed into clipping and heavy distortion can occur. A slow time constant means that initial sounds overmodulate before the system can compensate for them.

Compressors, especially those without careful audio-frequency pre-emphasis, may actually degrade the intelligibility of the transmitted signal while appearing to put out more power since a receiver S-meter may read considerably higher due to the fact that the compressor is integrating background noise into the transmission.

audio clipping

Like an audio compressor, an audio

amplitude limiter is an apparently simple device that may be inserted in series with the transmitter microphone input. If used intelligently it is possible to obtain at least 6-dB increase in effective power, equivalent to an input power increase of four times, albeit with considerable loss in the natural quality of the voice.¹⁰ Properly adjusted audio clippers prevent overdriving later transmitting stages.

All clippers operate by setting up a stage that will pass signals up to a certain amplitude but limit all signals greater than this level. The net effect of this is to put a flat top on the speech envelope which, at extreme clipping levels, approaches a train of square waves. Fourier analysis and practical experience show that a square wave with a 1:1 duty cycle generates the fundamental plus odd harmonics. If the square wave becomes even slightly asymmetrical even harmonics appear, so it follows that care should be taken to ensure that the clipping action is truly symmetrical.

Many published designs are open to the criticism that the clipping is accomplished by a simple pair of diodes. For the system to show its full capabilities some care must be given to the design of the clipper. Carefully matched silicon diodes with forward bias may be adequate, but a better approach is to use a true differential amplifier clipper as shown in **fig. 4**. Another approach is

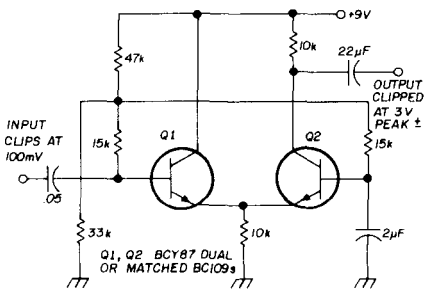

fig. 4. Differential amplifier clipper that provides gain as well as precise and symmetrical clipping.

to use an *operational amplifier-clipper* as shown in **fig. 5**. These have the additional advantage that they produce gain as well as limiting.

The high-order products produced by audio clipping can cause splatter. The

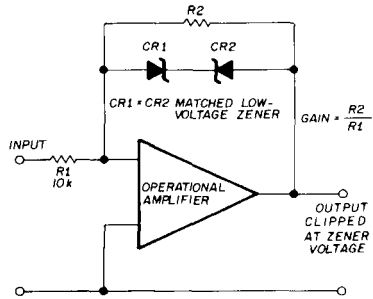

fig. 5. Operational amplifier used as an active audio clipper.

low-order products fall within the speech passband itself and cause distortion of the speech. This is one of the limiting conditions of audio clipping since it is clear that a point will be reached where increased clipping generates sufficient distortion products for intelligibility to drop. It is for this reason that frequency response shaping becomes so important in this system: if low-frequency speech components are reduced by a preamplifier with a band-pass like that shown in **fig. 1**, higher clipping levels can be obtained for a given degree of distortion.

split channel audio clipping

Another approach to the distortion problem in audio speech clippers is to divide the speech spectrum into bands which are independently clipped and filtered. The general idea is shown in the block diagram of **fig. 6**. Although I have not been able to trace a detailed discussion of this system, one reference¹⁴ gives a performance curve of such a device showing results comparable to an rf clipper up to 30-dB clipping level. Another device of this type is under

development by R. Newsome¹¹ but full results are not yet available.

Another advantage of splitting the speech into channels in this way is that by adjusting the gain of each channel the system can be easily optimized for individual voice characteristics. The disadvantage of this system is the increased complexity. Nevertheless, it is com-

with considerable sophistication if satisfactory operation is to be achieved. This problem has been discussed elsewhere.^{4,5} One solution is to use a passive filter section preceding the active filter. By careful choice of values it is possible to achieve an attenuation of around 20 dB per octave above 3 kHz with little overshoot. Such filters should

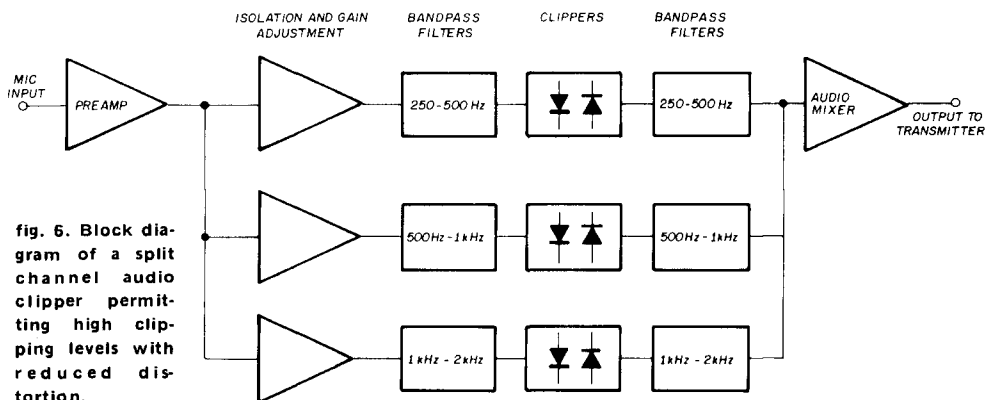

fig. 6. Block diagram of a split channel audio clipper permitting high clipping levels with reduced distortion.

posed of inexpensive components and is an obvious project for amateur experimenters since it can be set up with fairly elementary test gear.

At first glance it seems a simple job to get rid of the high-order clipping products that fall above the speech band. Note that it is also necessary to cut off the upper speech frequencies prior to the clipper; otherwise they would interact with the high order harmonics and produce further intermodulation products that fall in the desired passband. The problem is to produce a filter that sharply attenuates frequencies above about 2.5 kHz. Such a steep filter requires either high-Q LC circuits or active RC filters. Filters of this type tend to overshoot (ring), and in this application this means that when each clipped wavefront passes through the filter, spurious pulses are generated which overload the subsequent stages.

It is clear that the lowpass filter following the clipper must be designed

to be checked for ringing by feeding 1-kHz square waves through them.

In summary, it can be said that audio clipper-filter type processors can be made to give a very good account of themselves, but considerable care must go into their design. A good example will be as intelligible as an rf clipper up to about 20-dB of clipping although the rf clipper will sound much nicer. A bad audio clipper will sound awful long before 20-dB clipping is reached and, like some compressors, may result in a bigger but less readable signal. Compared with a full rf clipper the single-channel audio clipper shows advantages of cost-effectiveness and may be easily transferred from one rig to another. Audio clippers work well on fm, too.

rf clippers

Since rf clippers have been discussed at length elsewhere,^{10,12,13} they will not be discussed in detail here. It is worth noting, however, that few of the discus-

sions on rf clipping mention audio pre-emphasis as described in this article. If audio-frequency shaping is added to an rf clipping system increased effectiveness will result.

It is remarkable how little work has been done on the most elementary form of rf clipping: clipping the double-sideband signal after the balanced

undesirable feature that as the diodes go into clipping they load both the filter and the balanced modulator. This must add distortion to the signal. A more sophisticated system would be to use isolating amplifiers between the modulator, clipper and filter with a proper differential amplifier clipper. Fully developed, the results should be at least

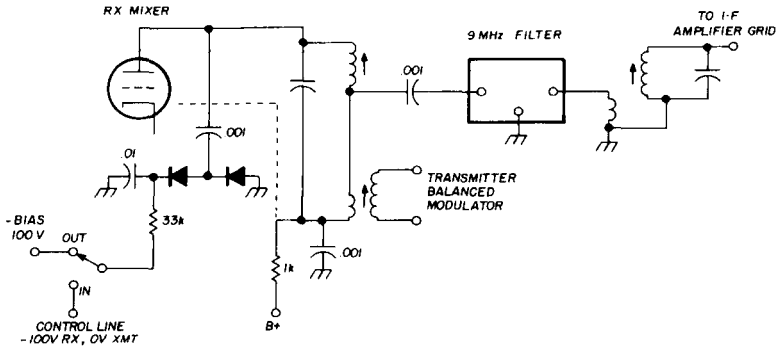

fig. 7. Simple diode clipper operating upon the double-sideband suppressed carrier signal prior to the filter in a Yaesu FT-200 transceiver. Diodes are unbranded high-speed computer types.

modulator and prior to the existing ssb filter. A practical circuit using this system is given in fig. 7 and has been a great success at ZL1BN; a Yaesu FT-200 so fitted ran up nearly a million points for a national win in the 1971 ARRL DX test, not to mention wins and places in other contests. With the microphone gain up full, the output reads over twice normal without running into alc while voice quality is excellent. Note that the coupling capacitors in the speech amplifiers have been reduced.

This unit represents the greatest increase in transmitter effectiveness per unit cost I have ever seen. Certainly it doesn't have the potential of formal ssb clipping, but heavier clipping of any sort would probably show up the limitations of the power-handling capability of the sweep-tube finals. As things stand they go on year after year without replacement.

The system shown in fig. 7 is about as primitive as one can get and has the

as good as the best possible audio processor.

It is worth remembering that whatever system is used, extraneous noise becomes more and more prominent in the transmitted signal as clipping levels rise beyond 20 dB or so. It is possible to reduce environmental noise to a degree but it is quite a trick to talk without breathing.* This is a consideration to be taken into account before scrapping a system with moderate clipping for one that might provide more. For practical purposes 30-dB clipping can be taken as an upper limit.

It is generally recognized that the final amplifying chain of the transmitter must have sufficient power capability to take the increased duty cycle of clipped speech ssb. Apart from the risk of thermal breakdown of components,

*It would be good practice to precede the clipping stage with a squelch circuit to eliminate background noise between speech syllables.

operators should check the dynamic characteristics of the final amplifier stage by running a series of dots and dashes from an electronic key and examining the envelope of the CW output with an oscilloscope. Waves in

frequency and then converted back to audio and fed into the microphone jack of an unmodified transmitter (as in fig. 8). This system has most of the virtues of both rf and audio clipping and it is surprising that amateur versions are not

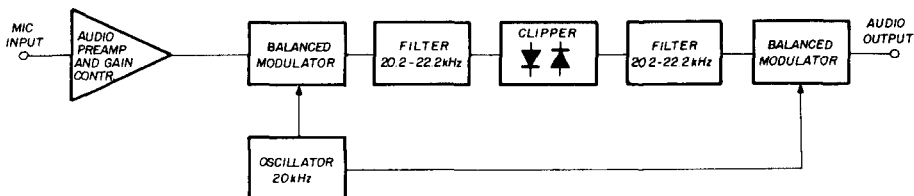

fig. 8. Block diagram of a speech processor in which the clipping is done at a low radio frequency and then converted back to audio to be fed to the microphone input of a transmitter.

the top of the pulses are usually a symptom of poor dynamic regulation in the power supply and imply a rapid increase in spurious output from the transmitter if run at full bore on clipped ssb.

other systems

In the speech-processing circuit used in the commercial Comdel processor¹⁵ the signal is processed at a low rf

common in the literature.¹⁶ Since the cost of ceramic filters for 455 kHz is dropping relative to the cost of many other components this system would compare very favorably with the more elaborate audio speech processors in cost-effectiveness. This would seem to be the method of choice for the experimenter wanting to increase communication power without making internal changes to his ssb transmitter.

references

1. H. Fletcher, *Speech and Hearing*, Van Nostrand, New York, 1929.
2. J.C.R. Licklider and G.A. Miller, "The Perception of Speech," in S.S. Stevens' *Handbook of Experimental Psychology*, John Wiley, New York, 1951.
3. V. Aumala, OH2CD, "Pre-Emphasis for SSB Transmitters," *ham radio*, February, 1972, page 38.
4. D.E. Schmitzer, DJ4BG, "Speech Processing: Practical Circuit of an Efficient AF Clipper," *VHF Communications*, February, 1971, page 1.
5. D.E. Schmitzer, DJ4BG, "Speech Processing," *Radio Communication*, May, 1972, page 292.
6. E.H. Conklin, K6KA, "To Clip or Not to Clip," *ham radio*, April, 1969, page 24.
7. *The Radio Amateurs Handbook*, ARRL, Newington, Connecticut, 1974.
8. G.A. Nurkka, VK9GN, "Integrated-Circuit Single-Sideband Speech Processor," *ham radio*, December, 1971, page 31.

9. J.M. Bryant, "Miniature Microphone Pre-amplifier With AGC," *ham radio*, November, 1971, page 29.
10. D.E. Schmitzer, DJ4BG, "Speech Processing," *VHF Communications*, June, 1970, page 218.
11. R. Newsome, Department of Psychology, University of Queensland, Australia (Personal Communication).
12. W.K. Squires, W2PUL and E.T. Clegg W2LOY, "Speech Clipping for Single Sideband," *QST*, July, 1964, page 11.
13. L.A. Moxon, G6XN, "Performance of RF Speech Clippers," *ham radio*, November, 1972, page 26.
14. H. Schneider, "Die Verständlichkeit Amplitudengrenzter Sprache," *Frequenz* (1956) No. 4, page 97; No. 5, page 152.
15. J.R. Fisk, W1DTY, "Speech Processing," *ham radio* June, 1968, page 68.
16. H.G. Elwell, Jr., W2MB, "RF Speech Processor for SSB," *ham radio*, September, 1973, page 18.

ham radio

No room? Get a ###hy-gain vertical antenna!



No. 182 No. 386 No. 193 No. 385 No. 384

Even if you're limited to just a few square feet of real estate, you've got room for a high performance Hy-Gain multi-band vertical. Great coverage in minimum ground space, or roof mount for optimum performance using Hy-Gain 12RMQ or 14RMQ Roof Mount/Radial Kit. All these antennas are entirely self-supporting.

18HT Hy-Tower 6 thru 80 meters

Unquestionably the finest multi-band omnidirectional vertical antenna available. Entire structure is radiating element with automatic band switching. All hardware iridited. Unique stub decoupling for 50 ohm input on all bands. Also operates 160 meters with loading coil. Takes maximum legal power with ease. No roof mount. Ht. 50'. Wt. 100 lbs.

Order No. 182

18AVT/WB 10 thru 80 meters

True $\frac{1}{4}$ wave resonance on all bands, automatic band switching and optimum wide-band performance combine to make the 18AVT/WB one of the most popular amateur antennas. Three heavy duty Hy-Q Traps, top loading coil, extra heavy duty construction. Roof mount with 14RMQ. Ht. 25'. Wt. 10.7 lbs.

Order No. 386

18V 10 thru 80 meters

Low cost, high efficiency, and quality construction make the 18V ideal for budget-conscious HAMs. Easily tuned to any 10-80 meter band by adjusting feed point at base inductor. Highly portable. Roof mount with 14RMQ. Ht. 18'. Wt. 4.6 lbs.

Order No. 193

14AVQ/WB 10 thru 40 meters

Improved for even greater wide-band performance! Three separate Hy-Q Traps with oversize coils for extremely high Q. $\frac{1}{4}$ wave resonance on all bands. Outstanding low angle radiation pattern. Roof mount with 14RMQ. Ht. 18'. Wt. 8.6 lbs.

Order No. 385

12AVQ 10, 15 and 20 meters

Inexpensive tri-band vertical for performance with minimum investment in space and equipment. Low radiation angle. Roof mount with 12RMQ. Ht. 13'6". Wt. 6.8 lbs.

Order No. 384

For prices and information, contact your local Hy-Gain distributor or write Hy-Gain.

###hy-gain

Hy-Gain Electronics Corporation, 8601 Northeast Highway Six, Lincoln, NE 68507; 402/464-9151; Telex 48-6424. Branch Office and Warehouse, 6100 Sepulveda Blvd., #322, Van Nuys, CA 91401; 213/785-4532; Telex 65-1359. Distributed in Canada by Lectron Radio Sales, Ltd.; 211 Hunter Street West, Peterborough, Ontario.

phase-locked loop RTTY terminal unit

Easy to build
phase-locked loop
RTTY terminal unit
uses only three ICs
and requires no
tuned circuits

Here's a simple RTTY terminal unit which should interest both the beginner and the old timer. It is easy to build and adjust, and does a good job of copying both wide and narrow shift. The circuit, shown in **fig. 1**, uses a 741 op-amp IC, U1, as a limiter, an NE565 phase-locked loop, U2, another 741, U3, as a voltage comparator or slicer, and an MJE340 keying transistor.

This terminal unit requires no filters because it works on the fm principle. Although the theory of the phase-locked loop has been covered extensively elsewhere, a short discussion will be helpful. Simply stated, the incoming

signal locks onto a voltage-controlled oscillator, the oscillator frequency is placed between the frequencies of the mark/space tones. As these tones alternate, the output of the PLL can be made to produce plus and minus voltages by connecting a voltage comparator to the output of the NE565. This plus and minus voltage corresponds directly to the mark/space tones and can be used to key the loop circuit of your teleprinter.

This method of RTTY demodulation has the advantage of requiring no tuned filters and will tolerate considerable drift and copy shifts from 170 to 850 Hz simply by properly tuning in the signal.

Construction of this circuit is not critical and a perf board will serve quite well.* A regulated power supply providing ± 10 -12 Vdc is required. A tuning meter is required and the simplest is a zero-center milliammeter with suitable dropping resistor as shown in **fig. 1**. It indicates a plus current on *mark* and a minus on *space*. When receiving a properly tuned FSK signal the needle tends to hover around the zero center. If a zero-center milliammeter is not available, use a vtvm set to about 25 Vdc and advance the needle to center scale.

*Just prior to publication the author advised that he has designed a PC board for this PLL terminal unit. Undrilled circuit boards are available from his for \$4.75 each. Completely wired and tested units are available for \$25.95. Editor

Nat Stinnette, W4AYV, Post Office Box 1043, Tavares, Florida 32778

alignment

Adjustment is easy: after connecting the loop voltage and the power supply to the terminal unit, check the plus and minus voltages. These can be from 10 to 12 volts but should be within 0.5 volt. The input can be 500 ohms or the speaker output from your receiver. Close switch S1, tune in a good, steady narrow-shift RTTY signal, preferably running a tape. The received tones should be in the vicinity of 1500 Hz. This can be done by ear and is not at all critical. Set potentiometer R1 at the end of rotation (maximum resistance). The zero-center meter should read ap-

proximately zero or a little on the plus side. Now advance R1. The meter should move more to the plus side and flicker back toward zero. If it does not, change sidebands if you are receiving in the ssb mode.

If receiving in the CW mode, move the bfo to the other side. Open switch S1 and turn on the teleprinter. As R1 is further advanced a point will be reached where the machine will begin to print and the needle of the meter will stay pretty near zero during copy and maximum plus on mark/hold tone. This is the proper adjustment for R1. As R1 is advanced further the meter needle will move toward the minus side and the machine will eventually run open.

With a little tuning practice and watching the meter a signal can be tuned in with no difficulty. After a while you may want to adjust R1 slightly one way or the other to receive signals better at some slightly different tone. However, once it has been properly set it need never be changed. With the audio input off the vco can be heard by connecting headphones between pins 4-5 of U2 and ground.

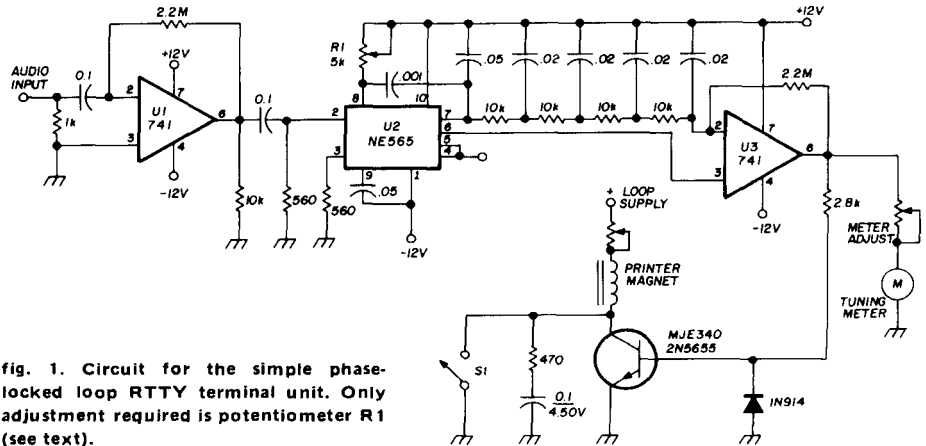

fig. 1. Circuit for the simple phase-locked loop RTTY terminal unit. Only adjustment required is potentiometer R1 (see text).

proximately zero or a little on the plus side. Now advance R1. The meter should move more to the plus side and flicker back toward zero. If it does not, change sidebands if you are receiving in the ssb mode.

If receiving in the CW mode, move the bfo to the other side. Open switch S1 and turn on the teleprinter. As R1 is further advanced a point will be reached where the machine will begin to print and the needle of the meter will stay pretty near zero during copy and maximum plus on mark/hold tone. This is the proper adjustment for R1. As R1 is

advanced further the meter needle will move toward the minus side and the machine will eventually run open. With a little tuning practice and watching the meter a signal can be tuned in with no difficulty. After a while you may want to adjust R1 slightly one way or the other to receive signals better at some slightly different tone. However, once it has been properly set it need never be changed. With the audio input off the vco can be heard by connecting headphones between pins 4-5 of U2 and ground.

It is possible to receive both wide and narrow-shift RTTY with one setting

ham radio

1200-MHz frequency scalars

New Fairchild
sub-nanosecond
logic circuits
can be used
to build
frequency scalars
that operate
to beyond 1000 MHz

Doug Schmieskors, WB9KEY, 330 West Greenmeadows Boulevard, Streamwood, Illinois 60103

Fairchild Semiconductor has recently introduced the 11C00 family of sub-nanosecond logic for instrumentation applications. The entire family is voltage compensated to improve noise margins and eliminate the $\pm 2\%$ power-supply regulation requirements of uncompensated ECL ICs, thus making system design much more simple. Isoplanar II processing is used to achieve maximum speeds and keep die size to a minimum. At this writing the logic family consists of only about six devices, but two of these should be of immediate interest to the amateur.

GHz prescaler

The 11C05 is an asynchronous divide-by-four counter which operates from a single power supply and features toggle rates in excess of 1000 MHz over the entire 0°C to $+75^{\circ}\text{C}$ temperature range. The input may be ac or dc coupled so that either an input amplifier or a simple biasing network may be used. The single rail power requirement allows the use of a +5 volt supply in predominately TTL systems. The 11C05 will toggle with a sinusoidal input to a minimum of about 25 MHz, or, with a square-wave input having fast edge rates, to dc. A circuit showing the 11C05 in a divide-by-forty uhf prescaler appears in fig. 1. The many owners of existing 95H90 vhf prescalers will be pleased to note that the 11C05 can be directly interfaced to their present circuits with a minimum of modifications.

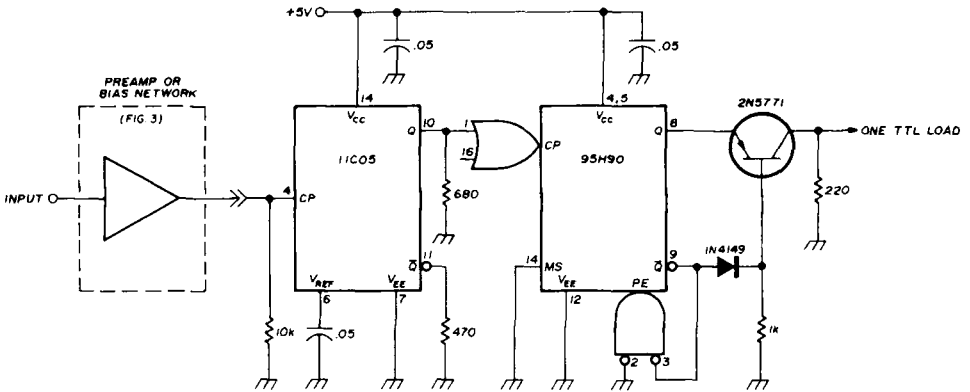

fig. 1. Divide-by-40 prescaler for use to above 1000 MHz uses 11C05 divide-by-4 counter and 95H90 decade divider (unused CP input is tied to ground). Ac-coupled 11C05 input requirements vs frequency are plotted as shown in fig. 2.

As shown, with an input amplifier (an Amperex ATF417 was used in one design), the input sensitivity is better than 50 millivolts rms to above 1000 MHz. The 10k resistor from pin 4 to ground is included to eliminate noise triggering in the middle frequency ranges. A glance at fig. 2, a plot of input sensitivity vs frequency, shows that this is necessary. Fig. 2 also shows that no input amplifier is necessary between about 150 and 800 MHz if a minimum-cost design is desired. The function of

the remaining termination and bypassing components associated with the 11C05 is obvious.

The balance of the prescaler consists of the 95H90 in a standard configuration with the 2N5771 used as an ECL-to-TTL level translator capable of driving one unit load. Although the diode used from the 2N5771 base to the \bar{Q} output of the 95H90 was a low-capacitance 1N4149 type, the more common 1N4148 should perform satisfactorily.

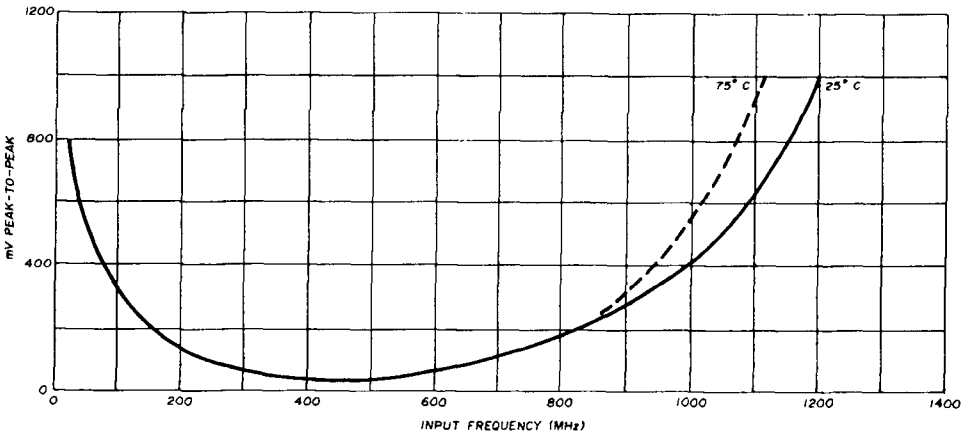

fig. 2. Ac-coupled input requirements for the Fairchild 11C05 1000-MHz divide-by-4 counter.

The less popular 95H91 divide-by-five counter may be directly substituted for the 95H90 with no change in wiring. This results in a divide-by-twenty prescaler suitable for use with counters capable of 50-MHz input frequencies and offers some additional advantages, e.g., mental multiplication of the counter reading by two is easier than multiplication by four. Also, a simple timebase divider can be built to double the gate time and yield the correct display.

uhf prescaler

The 11C06 is a 700-MHz type-D flip-flop. When used as shown in fig. 3, a divide-by-twenty uhf prescaler with toggle rates in excess of 550 MHz from 0°C to +75°C is the result. Again, an amplifier or an input biasing scheme may be used. An unamplified input was chosen for this design to illustrate its simplicity and also its adaptability to the 11C05. This circuit may also be used with existing 95H90 designs, or a 95H91 could be substituted to build a uhf decade prescaler that eliminates the need for mental gymnastics or time-base modifications. The only concern is that the counter must accommodate the desired maximum frequency divided by ten.

operation

As noted above, when either of these prescalers is used with most counters, it will be necessary to multiply the reading by the scale factor or to build a simple binary divider and insert it into the circuit between the crystal and the existing divider chain. This divider should then be switched into operation anytime the prescaler is in use. An unused set of contacts on this switch could be used to reposition the counter's decimal point one place to the right to reconcile the decade of division. The only drawback to the time base extension is the doubling of the gate time which results in a two-second gate

and a four-second wait for display update. However, to most people, the correct display is probably worth the wait.

No 1296-MHz signal source was available for testing, so it is not known whether the 11C05 prescaler can be used at this frequency. However, it appears that some devices would operate successfully, particularly at lower temperatures.

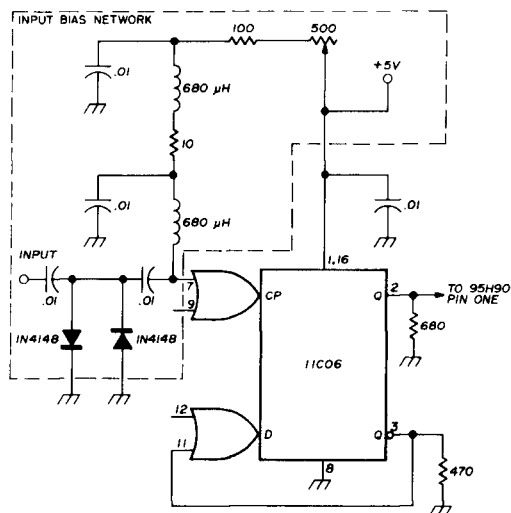

fig. 3. The Fairchild 11C06 700-MHz type-D flip-flop may be used with a 95H90 decade counter to build a divide-by-20 prescaler, (unused CP and D inputs are ties to ground).

conclusion

In summary, the Fairchild 11C00 series of sub-nanosecond logic has extended the range of digital techniques beyond 1000 MHz. As additional elements such as phase-locked loops, wide-band amplifiers, phase and frequency comparators, etcetera, are added, the applications base will broaden to include communications, frequency synthesis and data handling. In small quantities the 11C05 is \$87.90 and the 11C06 is \$21.97; both are available through franchised Fairchild distributors.

ham radio

fm channel scanner for the Heathkit HW202

Adapting K2ZLG's
popular vhf scanner
circuit to the
Heath HW202

The scanner described by K2ZLG in the February, 1973, issue of *ham radio* can be built into the popular Heathkit HW202 vhf transceiver at a cost of about ten dollars, making a fine addition to the unit. It is extremely useful when mobiling in areas of light two-meter activity and saves wear and tear on the channel-selector pushbuttons (as well as the operator's fingers).

Ken Stone, W7BZ, 641 Grant Avenue, Twin Falls, Idaho 83301

The circuit in **fig. 1** is essentially the same as that described by K2ZLG. However, all parts not required for operation with the HW202 have been eliminated. One unexpected but fortunate parts saving resulted from the discovery that power can be supplied to the scanner by connecting it in series with the lamp that illuminates the panel meter. This results in less battery drain than when the circuit is powered by a separate voltage-dropping resistor and zener diode. Somewhat less than the optimum five volts is supplied to the ICs, but due to the relatively slow toggling speed, no problems have been encountered.

The lamp behind the meter, however, blinks a bit with the scanner's fluctuating load; if this bothers you, a zener-regulated supply can be installed. To operate the receiver in the scan mode, it is only necessary to turn on the scanner power and depress one of the channel selector buttons part way so that all three are unlatched. If you wish to manually select one of the channels, power to the scanner must be removed so that two crystals cannot be switched in at the same time.

construction

The scanner is designed to fit into the space normally occupied by the optional Heath tone-encoder kit. If you have already installed the tone encoder you might be able to mount the scanner externally. However, it would be better to consider outboarding the tone encoder due to the number of leads involved with the scanner circuit.

toggle switch with a shank long enough to go through one of the holes in the sub-panel and also reach through the plastic strip.

Another amateur who modified his unit obtained a small slide switch from a hobby shop which worked as well and mounted nicely on the plastic strip. Either way, a little care is required to get everything to fit together properly

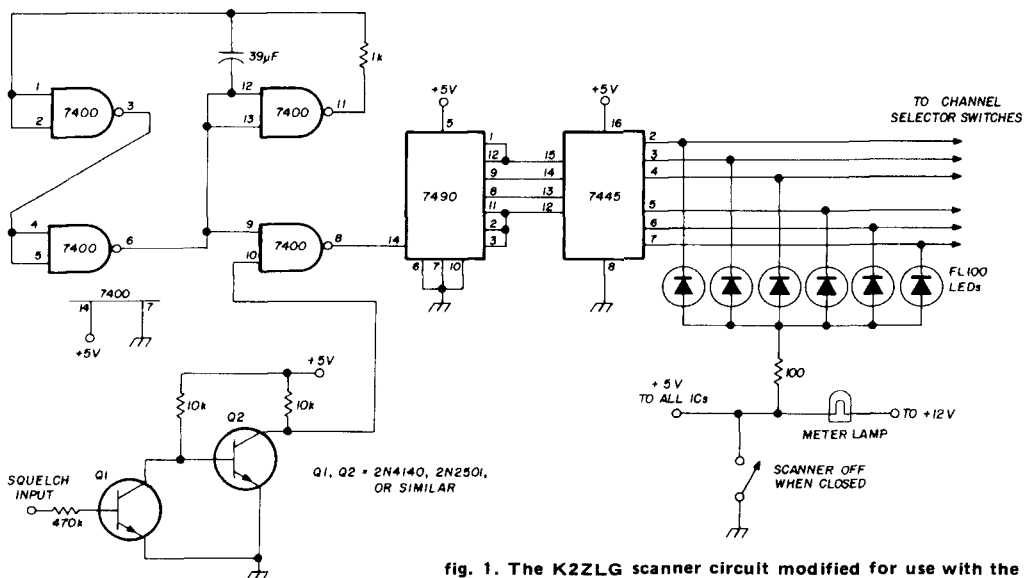

fig. 1. The K2ZLG scanner circuit modified for use with the Heath HW202 fm transceiver.

The parts were assembled on a printed-circuit board which was tested for correct operation before permanently mounting it inside the transceiver. There is nothing critical about it, and hard-wired or perf-board construction will work as well as printed circuitry.

The LEDs and the scanner on/off switch were mounted on the plastic filler plate which was removed from the front panel. Holes were pierced in the plastic strip and the LED leads were run through the holes and extended through a hole in the sub-panel with color-coded wires. The color code was matched to similar wires connected to the channel switches. The on/off switch is a small

without shorting any of the LED leads during assembly. Be sure to observe polarity when connecting the LEDs.

It is necessary to partially remove the front panel for easy access to the receive channel pushbuttons. After you get to them, connect a color-coded wire to each of the two unused lugs at the bottom rear of each of the three channel buttons. Then bring all six wires out to the side of the chassis and reassemble the switches and the front panel. It is helpful during the debugging process if you make these wires fairly long. They can be easily shortened later.

The scanner input lead is connected to the base circuit of Q107, the squelch

emitter follower. The upper end of R174, an 82k resistor, is a convenient point to make this connection without removing the receiver circuit boards.

As mentioned before, power is obtained from the lamp circuit. This is easily done by removing the ground connection from the base of the lamp and connecting the positive input of the scanner board to this point.

testing

When all the connections have been made and power applied to the transmitter, the LEDs should light in sequence from left to right. Manually opening the squelch, or an incoming signal on any channel, should stop the searching action. You may have to adjust the value of the 470k resistor in the squelch input circuit slightly, depending on the gain of the transistors used on the scanner board. The rate at which the scanner operates can be adjusted by changing the value of the timing capacitor in the 7400 clock circuit. The 39- μ F value results in a scan rate of about six channels per second.

circuit noise

After getting the scanner in operation, you may notice a clicking noise that can be quite annoying, especially in a quiet room. These clicks are simply key clicks from the switching oscillator stage in the receiver and can be reduced by connecting a 2700-ohm resistor from the base of transistor Q116 to ground (the oscillator stage). The resistor will reduce the transistor's forward bias during the time the scanner is moving from one channel to another. In addition, the emitters of transistors Q109 and Q110 are returned to ground through R183 which is grounded to a portion of the PC foil shared by the oscillator stage. A 680-pF capacitor from the emitters of Q109 and Q110 to the nearest ground on the circuit board should completely eliminate the clicks.

ham radio

a **second look** (from page 4)

while others are opposed because a large number of Communicators on our vhf bands would create undesirable crowding and interference. Remember, however, that our vhf allocations are very susceptible to raiding by other radio services — a healthy and growing amateur population is probably the most effective weapon we have.

If the proposed regulations are adopted, the written examination for the Advanced Class will apparently be essentially that which is now required for the Amateur Extra Class. If you've been thinking about going for your Advanced ticket anyway, perhaps now is the time to consider it seriously because the present examination is probably considerably easier than the new one will be. And, if the new regulations are adopted, the only privileges the Advanced Class will be denied are the small high-frequency CW segments which will continue to be reserved for the Extra Class.

Under the new scheme, incidentally, the Extra Class exam will consist only of a 20 wpm telegraphy test. This class will carry *both* high-frequency and vhf privileges, and will be issued for life (only the station license need be renewed every five years). The new regulations will also give Technicians full six- and two-meter privileges (50.0-50.1 and 144-145 MHz), so nearly everybody gains.

Docket 20282 is probably the most far-reaching proposal affecting amateur radio which has ever been issued by the FCC, and it deserves the attention of all of us. Since copies of the complete Docket have been sent to all the subscribers of *ham radio*, and the ARRL has sent copies to all their affiliated radio clubs, the material is widely available. Read it, then stand up to be counted. Comments are due at the FCC by June 16, 1975.

Jim Fisk, W1DTY
Editor-in-Chief

transistor breakdown voltages

A complete discussion
of transistor
breakdown voltages,
what the ratings mean,
and how they affect
the application
of the device

The pages of all the electronics magazines are presently filled with lucrative offers of all types of semiconductor devices, and many of the prices are really quite reasonable! Most amateurs operate on a limited budget anyway, so these offers are quite tempting. The ads often state "...replaces types..." but all too often this is not the case. Why?

One of the major stumbling blocks to a thorough understanding of the applications of transistors is the lack of a working knowledge of transistor breakdown voltages. Breakdown in a device

can often lead to its sudden and mysterious failure without leaving any trace as to what happened. Another similar device is then inserted, and the same thing may or may not happen. It's no wonder that the amateur who does his own design or substitutes "grab bag" goodies into a proven circuit is often mystified when the circuit fails to operate properly.

diodes

In its simplest form, breakdown in semiconductor devices can be observed in an ordinary diode. The diode is a junction of positive (p) and negative (n) type semiconductor materials, and theoretically will conduct current in only one direction. An illustration of this forward bias condition is shown in **fig. 1**. The relationship between the current i and the voltage v will be defined later.

If the diode is inverted in the circuit no current (except for reverse leakage current) will flow. This will remain true until the reverse voltage reaches a point where the current begins to increase almost without limit. The value of voltage at which this phenomenon occurs is known as the breakdown voltage. **Fig. 2** shows the "reverse bias" configuration which will lead to eventual breakdown.

Depicted in **fig. 3** is a graphical illustration of the relationship between diode voltage and current. In the forward bias region, current tends to in-

James E. McAlister, WA5EKA, 10 Leacrest Place, North Little Rock, Arkansas 72116

crease rather smoothly as voltage is increased. In the reverse bias condition, however, current flow seems to remain at some small and almost constant value until breakdown occurs; reverse current then increases very rapidly. The reverse current is referred to on data sheets as "reverse saturation current"; symbolically, it is called I_o . Both I_o and BV vary considerably among individual devices, and ranges of values are sometimes presented on data sheets along with other pertinent characteristics.

It should be noted that the well known and widely used zener diode is actually a diode used in the reverse bias region. Its breakdown or *zener* voltage is closely controlled and specified.

In diodes, the reverse breakdown voltage is sometimes called "peak inverse voltage," or PIV. In the selection of rectifier diodes, proper attention to

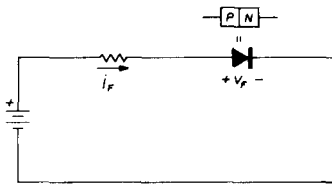

fig. 1. Forward-biased semiconductor diode.

PIV is always given for the potential of breakdown is quite clear.

transistors

Now that some insight into a diode's behavior has been given, transistors can be tackled! Consider the circuit of fig. 4. In this particular case the collector-base junction can be treated simply as the ordinary diode just discussed. As before, a reverse leakage current (now called I_{CO}) flows through the collector-base junction and some value of reverse bias will eventually be reached where I_{CO} begins a rapid increase. This, again, is the value of the breakdown voltage, and is designated as BV_{CBO} . Stated another way, it is the breakdown volt-

age between collector and base with the emitter lead unconnected ($I_e = 0$).

Even if some emitter current is allowed to flow, the breakdown point will still approach BV_{CBO} , but the current increase is not as dramatic as when I_e is zero. Fig. 5 will clarify this. A similar condition exists whenever the base ter-

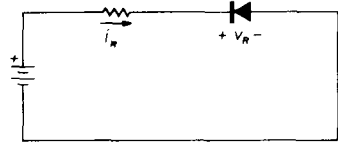

fig. 2. Reverse-biased semiconductor diode.

terminal is left unconnected. This time, however, the voltage of importance is called BV_{CEO} (see fig. 6). Note that BV_{CEO} is less than BV_{CBO} . The actual difference is dependent upon the electrical parameters of the individual devices.

Strictly speaking, the open-circuit base is not often encountered, so some alterations should be considered. Connecting the base to the emitter through a resistor modifies the I_C/V_{CE} relationship as evidenced by fig. 7. With the resistor in the circuit, breakdown can be increased above BV_{CEO} to BV_{CES} . If the resistor is actually decreased to zero ohm, another value, BV_{CES} (the "s" is for short circuit) is obtained.

As if this weren't enough to remember, there is still one more breakdown voltage — BV_{CES} . This is generated by applying negative bias to the base. For

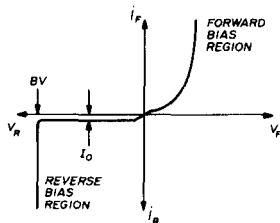

fig. 3. Typical characteristic curve of a semiconductor diode, showing operation in the forward- and reverse-biased regions.

the purposes of this discussion it is not necessary to know the empirical relationships between BV_{ce0} , BV_{cer} , BV_{ces} and BV_{cex} . However, knowing their approximate relationships to each other and under what conditions they become important should be one of your goals. Reference to fig. 7 should provide some insight into approximate magnitudes of the various breakdown voltages.

From this graph it can be seen that breakdown can range in values from a low of BV_{ce0} to a high of BV_{cbo} . By no means do these curves represent all transistor types; they are, in fact, somewhat idealized. In spite of this, they will give you a feel for the concept of breakdown.

using the data

At this point some attention should be given to the application of the

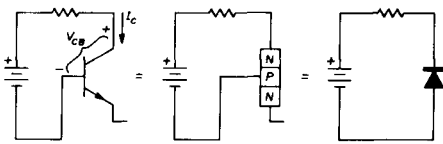

fig. 4. Diode equivalent of a transistor's collector-base junction.

various ratings just discussed. Each rating has its own special significance, and it would hardly prove practical to discuss each in detail. What will be useful, though, is the formulation of some general guidelines to help you in the application of the transistors themselves.

While it is unusual to find a wide variety of breakdown voltages specified on a data sheet, BV_{cbo} is commonly specified. In order to wisely apply a device, however, BV_{ce0} should also be known since it establishes the minimum breakdown voltage. Another item usually stated on data sheets is the static forward current transfer ratio, or dc beta; its designation is h_{FE} . The actual value of BV_{ce0} is dependent upon these two items just mentioned. It can, in

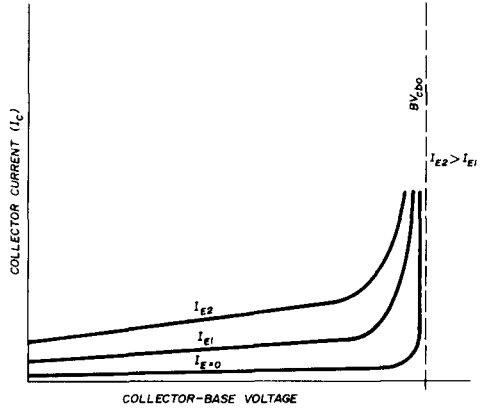

fig. 5. Transistor collector-base breakdown characteristics with the emitter open.

fact, be approximated from the equation

$$BV_{ce0} = BV_{cbo} / (1 + h_{FE})^{1/n}$$

where n is an experimentally determined factor. For purposes of approximation, you can assume n to have a value of 2.5 for silicon transistors and a value of 6.0 for germanium transistors. Fig. 8 is included to aid in the estimation of values for BV_{ce0} .

From the equation you can see that for a current gain of zero, BV_{ce0} will equal BV_{cbo} . With small-signal devices,

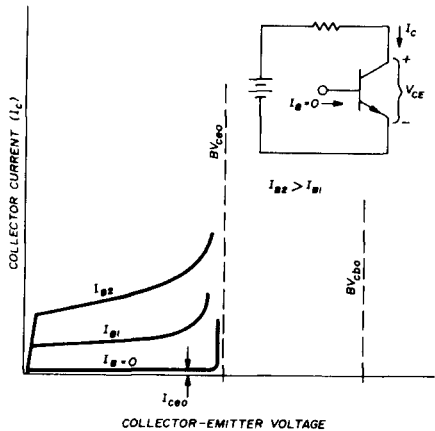

fig. 6. Transistor collector-emitter breakdown characteristics with the base open.

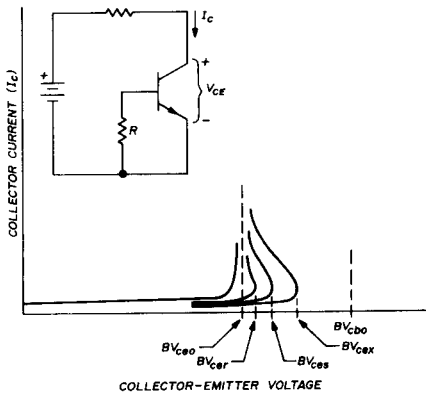

fig. 7. Transistor collector-emitter breakdown characteristics for various base biasing conditions.

current gain is usually rather large, so BV_{ce0} will, in most cases, be the smaller number by a rather wide margin. This has the practical significance of a built-in safety factor — use of the BV_{ce0} rating for selection of a device will almost always insure that breakdown ratings will not be exceeded because the base lead will probably not be anywhere near an open circuit. For additional reliability, though, an additional safety factor may be applied. In many military designs this factor will vary from 0.5 to 0.75. For amateur work, 0.75 will suffice.

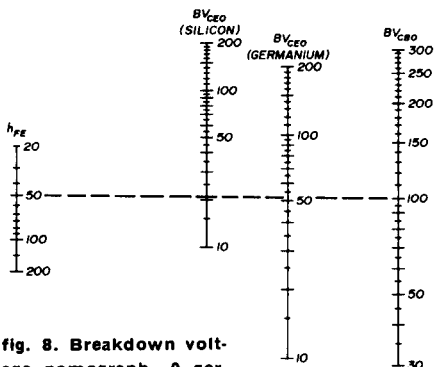

fig. 8. Breakdown voltage nomograph. A germanium transistor, for example, with a forward current gain (h_{fe}) of 50 and BV_{cbo} of 100 volts has a BV_{ce0} of approximately 52 volts (if the transistor were silicon, the BV_{ce0} would be slightly more than 20 volts).

The term “breakdown” carries with it the connotation of complete destruction, but this is not always the case. Device destruction often results because large voltages and significant current are present in a device simultaneously, and its power rating is exceeded. In many instances, however, breakdown is used to advantage. Current flow is limited to the extent that the product of current and breakdown voltage falls well within the dissipation rating for the device.

As previously mentioned, the zener diode is one application of controlled breakdown. The emitter-base junction of transistors (the breakdown voltage

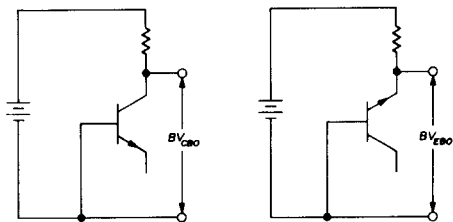

fig. 9. Using transistor junctions as zener diodes.

ranges from 0.5 to tens of volts, depending upon the device type) is often used as a zener diode. Similarly, the collector-base junction is sometimes connected for use as a high-voltage zener (voltages up to several hundred volts are possible). Fig. 9 illustrates these two common applications.

conclusion

From this discussion it should be clear that the term “breakdown voltage” does not refer to a single, well-defined quantity. Likewise, the process of breakdown in semiconductor devices is not an easy one to comprehend. While the presentation here is not intended to be exhaustive, the information should allow a reasonable approach to device selection and substitution.

ham radio

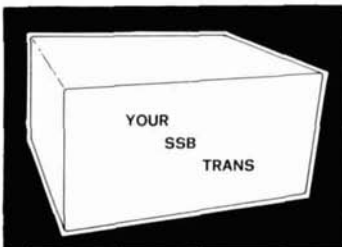

PLUS



EQUALS



AND---



Making
Amateur Radio
More Fun!



Here's a REAL plus

You will add a real plus to your SSB station when you give it complete 160-meter receive and transmit capability with the exciting new Dentron 160 XV Transverter. Just two simple connections with no modifications and you're on the air.

- 5 watts drive gives 100 watts DC input.
- Automatic input overload protection — you can not overload.
- 3.8 to 4.0 MHz input
- Matches 50 ohm antenna
- Built in 110/220 V 50/60 Hz supply

Dentron 160 XV Transverter

\$199.50 ppd. USA

plus even more!

Let the Dentron 160 AT antenna tuner solve your 160-meter antenna problems the easy uncomplicated way. This transmatch will load any random length antenna from a short whip to an extra-long wire. Use it with virtually any existing HF antenna you already have. Handles maximum legal power. Use with the 160-XV or any other 160 meter equipment requiring a 52 ohm antenna.

Dentron 160 AT Antenna Tuner

\$59.95 ppd. USA

Dentron

27587 Edgepark Dr.
North Olmsted, Ohio 44070
Telephone (216) 734-7388

Plus even more from Dentron

The exciting new 160-V Vertical Antenna

Here is a brand new vertical designed to operate on 160, 80 or 40 meters. Put this together with your triband beam and you have all the antennas you need for complete amateur coverage of HF & MF frequencies.

- Height overall 24' 7"
- Ground or Pole Mounting
- Base fed — Center Loaded
- Quick Band Change by adding or removing capacitive elements
- Excellent broad Bandwidth Characteristics
- Rugged — No guy wires required
- Easy one person assembly & erection

Write for full details

The all new 160-10 AT Antenna Tuner

Here it is. Amateur Radio's first 6 band antenna tuner. Covering all bands 160 through 10. You'll find everything you ever wanted in this exciting new product.

- Matches coax feedlines
- Matches balanced feedlines 300-450 ohms
- Matches single long wire antennas
- New compact, low profile design

Write for full details



Dentron

27587 Edgepark Dr.
North Olmsted, Ohio 44070
Telephone (216) 734-7388

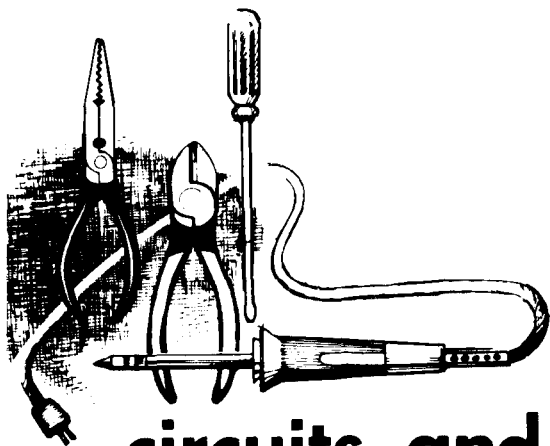

circuits and techniques

ed noll, W3FQJ

mosfet circuits

The metal-oxide semiconductor field-effect transistor (mosfet) is now used extensively in transmitters, receivers and test equipment. Some common and some unique circuits have been built around this device and are being used in both amateur and commercial communications equipment. They perform well as ampli-

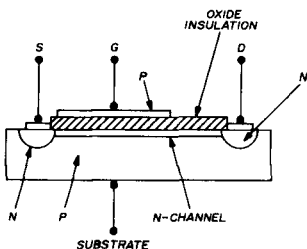

fig. 1. Construction of the depletion-type mosfet.

fiers up into the high uhf spectrum, and the dual-gate types are particularly popular in mixer, oscillator and converter circuits. In addition, they serve ideally as balanced modulators and demodulators.

Basically, the mosfet differs from the junction fet in that the gate itself does

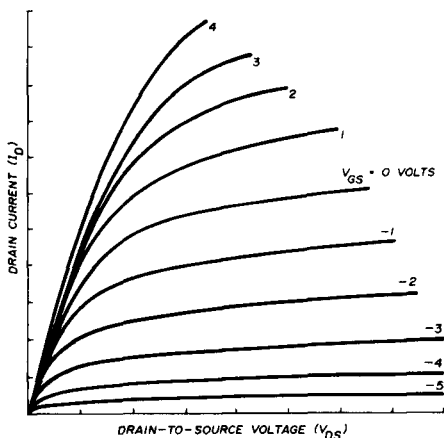

fig. 2. Operating characteristics of the n-channel, depletion-mode mosfet.

not actually touch the channel — there is an intervening metallic-oxide layer between gate and channel as shown in fig. 1. However, the gate electrode acts as a control element just as it does in a junction fet. The oxide insulation between the gate and the channel keeps the leakage current very low and the input impedance very high. Nonetheless, the charge placed on the gate determines the charge motion along the channel between the source and drain. As in the case of the junction fet, the gate charge determines the extent of the depletion region in the n-channel.

As the gate is made negative, relative to the source, the number of electrons in the channel is depleted. This activity is similar to that of a junction fet. During normal operation the gate of the junction

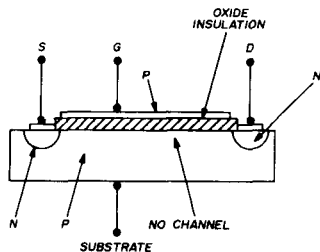

fig. 3. Construction of the enhancement-mode mosfet.

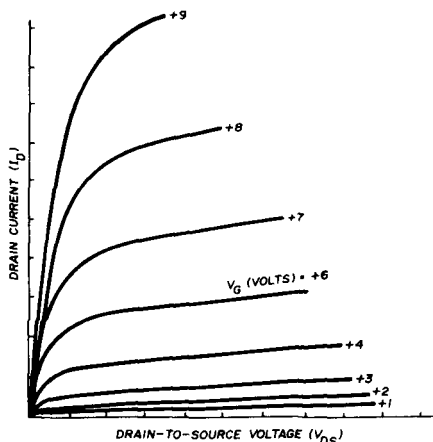

fig. 4. Operating characteristics of the n-channel, enhancement-mode mosfet.

fet may not be permitted to swing significantly past zero voltage because the junction will then be forward biased and input impedance falls. The mosfet has no such limitation; the gate can be permitted to swing past zero, increasing channel conductivity without any increase in the gate current or drop in input impedance.

The drain current vs drain voltage characteristic of a depletion-type mosfet is plotted in fig. 2. Note that the gate signal swings to either side of the zero-volt gate-bias curve. Drain current rises on the positive side; it falls on the negative side.

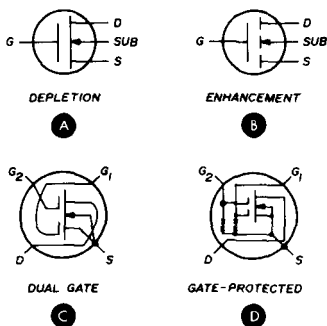

fig. 5. Symbols used for various mosfets. N-channel, depletion type is shown in (A); n-channel, enhancement-mode type is shown in (B). (C) shows dual-gate, depletion-mode device while (D) shows a diode-protected mosfet.

A second basic type of mosfet is the enhancement-mode device shown in fig. 3. In this device there is no channel present in the substrate that exists between the n-type source and n-type drain. With no bias applied to the gate there is no channel current. Likewise, a negative gate charge results in no channel current.

If a positive bias is placed on the gate of an enhancement-type mosfet it will attract electrons from the p-substrate into the region beneath the gate, forming an n-type channel that links the n-type source with the n-type drain. Consequently, there is a charge motion along

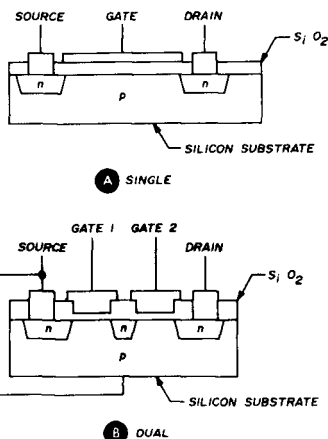

fig. 6. Construction of single- and dual-gate mosfets.

the channel which increases with the positive charge applied on the gate. If the positive bias voltage is made to vary with signal there will be a like change in the channel current. The I_D vs D_{DS} curves of fig. 4 show how the drain current increases with an increase in the positive gate bias.

The basic symbols for the different mosfet types are shown in fig. 5. These symbols signify an n-type channel. However, they can also use a p-type channel - the symbolization is identical with the exception that the substrate arrow must be pointed in the opposite direction. The symbol in fig. 5A refers to a depletion-

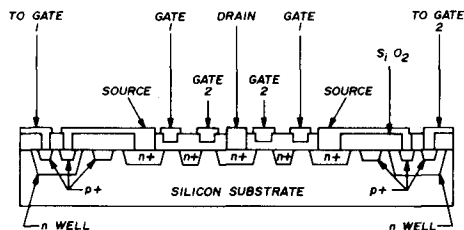

fig. 7. Dual-gate mosfet with diode gate protection.

type n-channel mosfet; fig. 5B refers to the enhancement-mode type. Fig. 5C and 5D refer to dual-gate, depletion-type mosfets. Fig. 5D refers to mosfets that include internal protective diodes.

The high input impedance is both an advantage and a hazard of the mosfet device. Since the input impedance is very high, a tiny current or static charge can build up a very high level on the gate, possibly destroying the device. Thus mosfets must be handled carefully and circuit arrangement must be such that excessive charges are excluded from the gate(s). The internal protective diodes avoid these hazards by establishing conducting paths when the gate charge becomes excessive.

dual-gate mosfet

The dual-gate mosfets bring added versatility to mosfet circuit design. The two gates and balanced configuration is attractive for all types of balanced amplifiers, modulators, mixers and demodulators. In straight amplifier and mixer applications the second gate provides a means of applying agc voltage or local-oscillator injection. Most dual-gate mos-

fets are n-channel depletion types, fig. 6. The two devices shown are similar except for the addition of a second gate. As a result there are two electrodes that control the conductivity of the channel. In fact, in mixer circuits the signal applied to gate 2 is used to modulate the transfer characteristics of the input gate. As a result there is a form of mixing that has improved linearity over conventional square-law devices. Good conversion gain is obtainable with minimum injection level.

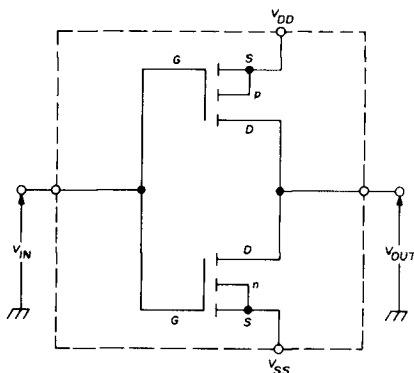

fig. 8. A complementary-symmetry/metal-oxide (cmos) circuit.

The addition of internal protective diodes protects the gates against damage from normal handling and use. These diodes drain off high-voltage charges and protect the input circuit from excessive voltages and signals. For example, any voltage transients in excess of ± 10 volts are bypassed by the back-to-back diodes connected between each gate and the

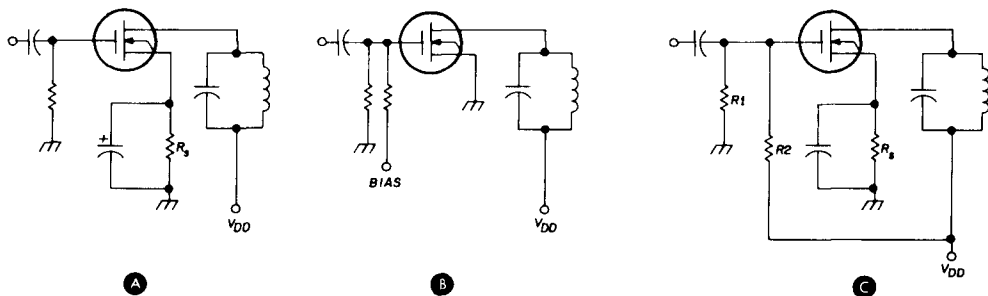

fig. 9. Biasing circuits for single-gate mosfets.

substrate. As shown in the basic structure of the gate-protected mosfet chip, **fig. 7**, there are two n-type input wells. The p-region of the gate forms a diode junction with the well, the well junction with the source serving as the second diode. It is interesting that such a protected-gate mosfet is less subject to static discharge damage than even a bipolar transistor.

Mosfets lend themselves to inclusion in integrated circuits. One of these is the popular cos/mos or cmos IC using both enhancement and depletion types. The term cos/mos (cmos) refers to compli-

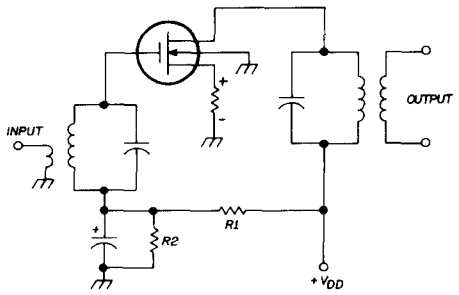

fig. 12. Mosfet rf amplifier circuit using resistor-divider biasing.

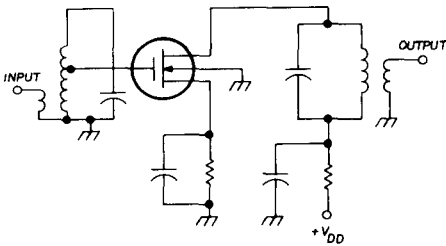

fig. 11. Simple rf amplifier circuit using a single-gate mosfet.

mentary-symmetry/metal-oxide semiconductor devices. Two enhancement-type mosfets are shown in the cmos IC in **fig. 8**. Note from the direction of the substrate arrows that the upper device has a p-channel and the bottom device an n-channel. Such configurations are especially adaptable to logic circuits incorporating the attractive features of high input impedance (low input capacitance) and very low power demand.

Biasing methods for the single-gate mosfet are given in **fig. 9**. The insulated gate provides a high input impedance and, like the pentode vacuum tube, there is no significant input current. The circuit in **fig. 9A** is biased with the source resistor R_s , the direction of source current being such that a positive bias is developed in the source circuit. This in effect biases the gate negative for the n-channel, depletion-type mosfet. Operation is similar to the cathode biasing of a vacuum tube. If degenerative feedback is wanted, the filter capacitor is eliminated from the source circuit.

External biasing, using a two-resistor divider, is shown in **fig. 9B**. In this arrangement the source and substrate are both grounded. The most popular form of mosfet biasing uses a combination of both types as shown in **fig. 9C**.

In circuit application there can be a considerable variation in drain current for individual devices. Thus, with a certain fixed bias, the actual drain current could fall between somewhat wide limits for a

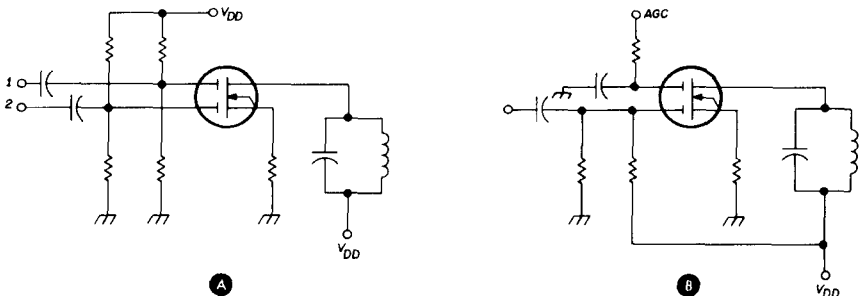

fig. 10. Biasing methods for dual-gate mosfets.

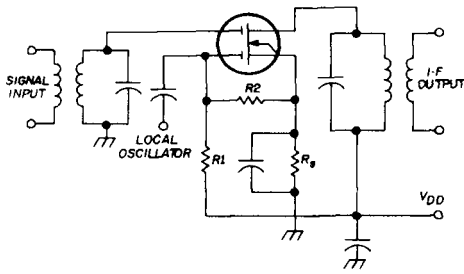

fig. 13. Mixer circuit using a dual-gate mosfet.

given transistor type. The combination of external divider bias and source resistor bias confines this limit to a much narrower range.

Dual-gate biasing schemes are shown in fig. 10. In fig. 10A a combination of two-resistor divider and source resistor bias are used. Note that there are two inputs, suggesting that the circuit could be used as a receiver mixer or for signal combining or switching. The circuit in fig. 10B shows a basic rf amplifier stage using

is required and/or critical operating conditions must be maintained, a combination of source and external bias can be used (fig. 12). The way in which the bias dividers are connected is such that there is minimum loading of the input resonant circuit. Instead, the bias voltage is developed across the capacitor connected between the bottom end of the resonant circuit and common. Therefore, it is not necessary to shunt the divider resistors between the high-impedance input gate

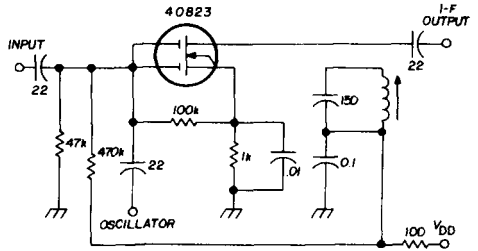

fig. 15. Mosfet dual-gate mixer.

and common as is the case for the bias arrangement shown in fig. 9C.

In the combination-bias arrangement it should be noted that negative gate bias is developed across the source resistor while the two-resistor divider results in a positive bias voltage. The actual gate bias is the algebraic sum of the two.

A very popular mixer circuit for modern receivers is shown in fig. 13. The signal is applied to the top gate; its bias is determined largely by the source resistor R_S . Local-oscillator injection is made at the lower gate. Optimum mixing bias is established by $R1/R2$ combination.

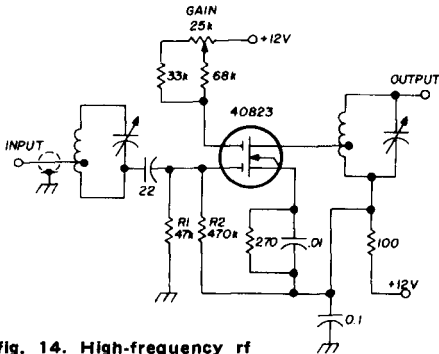

fig. 14. High-frequency rf amplifier using a dual-gate mosfet.

similar biasing. The exception here is that one gate is used for agc voltage or some other form of controllable bias, as from a receiver rf gain control.

basic circuits

A typical weak-signal rf amplifier using a single-gate mosfet is shown in fig. 11. In this circuit a small amount of source bias is used; the substrate itself is grounded.

When greater dynamic operating range

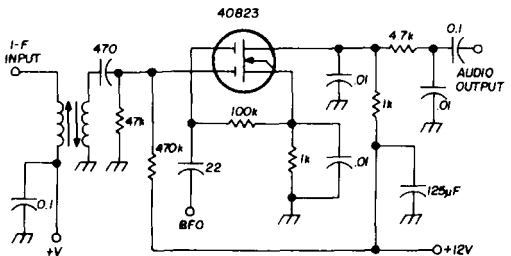

fig. 16. Product detector. Excellent isolation is provided by the dual-gate device.

receiver circuits

The circuits that follow are very practical ones gathered from proven amateur and commercial radiocommunication equipment. Parts values are given whenever they are known. The first three circuits are receiver types used in the Ten-Tec Argonaut transceiver. They demonstrate how a dual-gate depletion-type mosfet can serve in a number of basic receiver circuits.

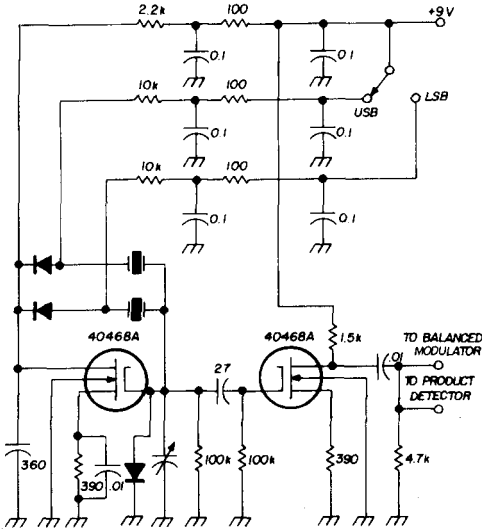

fig. 17. Sideband carrier oscillator using diodes for upper/lower sideband switching.

A high-frequency amplifier is shown in fig. 14. The input circuit has high Q and the low impedance of the antenna is matched through the tap at the low end of the coil. The input gate tap is further up the coil. A resonant output system is included in the drain circuit. In application this can be a high impedance output or, if a low impedance output is desired, it can be obtained by tapping at the low end of the output coil.

Input gate biasing is handled with divider resistors R1 and R2. The second gate is used to control the gain of the rf amplifier. Note the convenient manner in which this can be accomplished using two

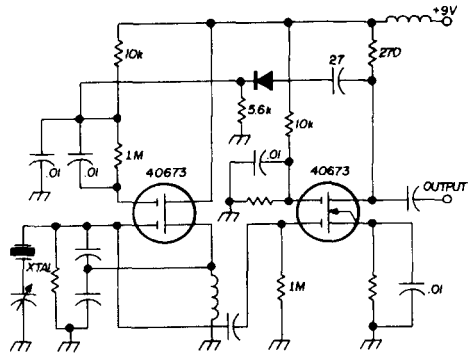

fig. 18. Wide range, untuned, high-frequency crystal oscillator.

fixed resistors and the gain control potentiometer.

A signal mixer circuit is shown in fig. 15. Separate gates provide input for signal and local-oscillator injection. Component values are similar to those of the rf amplifier except for the simple gate-input circuit for the local oscillator signal. The output resonant circuit is tuned to the intermediate frequency.

Fig. 16 shows the same mosfet being used as a product detector for demodulation of CW or ssb signals. Note the many similarities of the three receiver circuits. Such a device and associated components could be easily set up on a vector board if you wanted to try a bit of mosfet experimentation.

The i-f signal arrives by way of the input resonant circuit. The demodulating oscillator supplies signal to the second gate. High-frequency components are filtered out in the drain output circuit. A

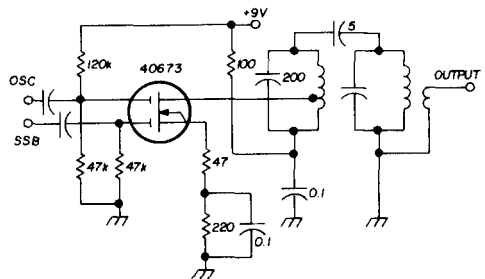

fig. 19. Sideband mixer circuit using a dual-gate mosfet.

resistor-capacitor lowpass filter passes the voice frequencies to a succeeding audio amplifier.

The next four circuits were gleaned from the sideband transceiver manufac-

circuit for the particular crystal to be activated. Since the unit is a transceiver, the output can be used as injection voltage in the demodulation of an incoming signal by the product detector or

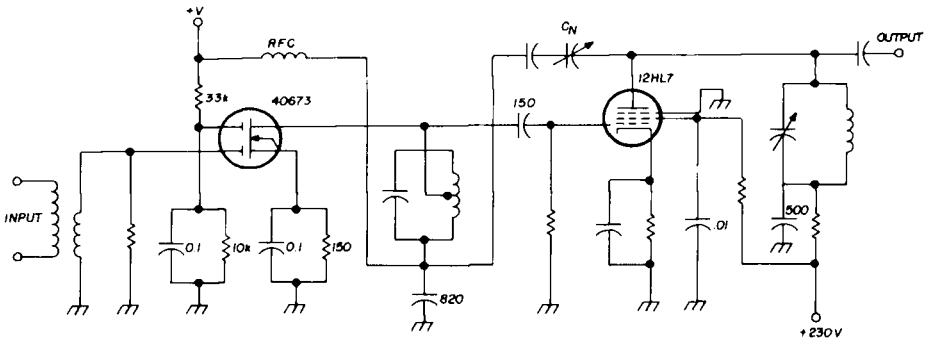

fig. 20. Using a mosfet amplifier to drive a vacuum-tube rf power amplifier.

tured by Sideband Associates (SBA) for operation in the 2- to 23-MHz range and used primarily for radio-marine communications. Two mosfet devices are used in the carrier oscillator, fig. 17, along with a diode switching arrangement that can be used to select either the upper or lower sideband. The 40468A is a single-gate device. The circuit between the gates serves as a means of coupling the oscillator to the isolating output stage.

The upper/lower sideband switch applies +9 volts to the anode of the switching diode that closes the feedback

as the basic carrier applied to the balanced modulator for the transmit mode of operation.

Since the transceiver must operate over a wide frequency range the channel oscillator must be able to accommodate crystals over a 2- to 23-MHz range. The two dual-gate mosfets operate in the untuned crystal oscillator circuit in fig. 18. The Colpitts type crystal oscillator is followed by an isolating amplifier stage. A small netting capacitor can be used for netting an individual crystal to a precise assigned frequency.

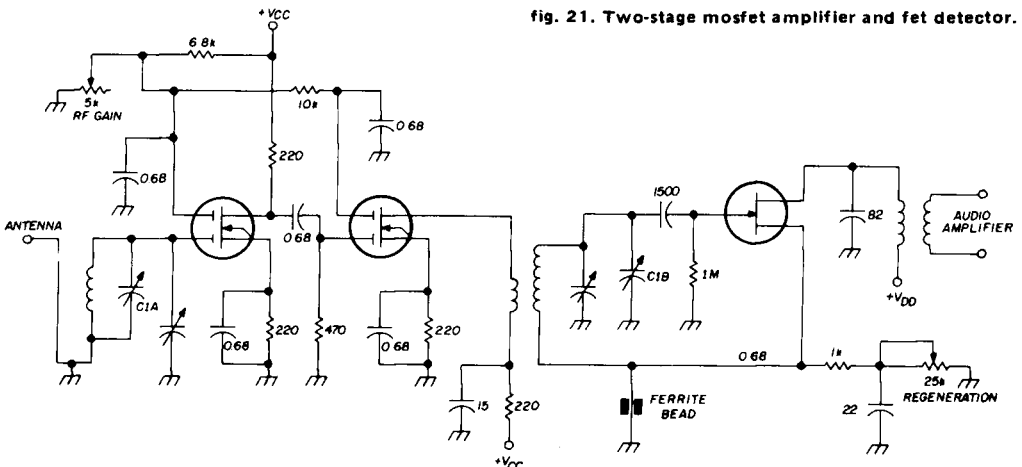

fig. 21. Two-stage mosfet amplifier and fet detector.

A transmit mixer is shown in fig. 19. The low-frequency sideband signal and high-frequency oscillator signal are mixed to produce a higher sum frequency at the output. A double-tuned resonant circuit provides adequate output bandwidth and excellent skirt rejection of undesired frequency components.

The ease with which a mosfet can be used to drive a vacuum-tube stage should be attractive to those of you who want to build a hybrid transmitter but just haven't gotten around to it. Fig. 20 shows a simple circuit arrangement that permits you to drive a modest power pentode with a mosfet. The channel frequency signal is applied to the input gate, amplified, and is resistor-capacitor coupled to the grid of the vacuum tube. To prevent instability and possible self-oscillation when operating over a wide frequency range a simple capacitive feedback link can be used. The neutralizing capacitor is adjusted for an optimum setting that covers the desired transmit frequency range.

If it's something different you wish to experiment with, and perhaps something that could be made quite effective for specific needs, take a look at the circuit of fig. 21. This is a two-stage mosfet rf amplifier followed by an fet regenerative detector (a TRF receiver). All I know about the circuit is given in the schematic. Maybe you'd like to expand upon it and come up with a small, low-power CW receiver. Two applications that come to mind are the 160-meter CW spectrum and the isolated segment of the 10-meter band assigned to novice operation. No doubt the receiver could be adapted to multiband operation as well as coverage over a wider frequency band with appropriate trimmers.

The gain control regulates the voltage applied to the second gate of both rf amplifiers. The dual-gate connection permits this isolation of gain control and signal circuits. The feedback path and regeneration control circuit is located in the emitter circuit of the fet detector.

ham radio



The "STANDARD" by Heights

Light,
permanently
beautiful
ALUMINUM
towers

**THE MOST
IMPORTANT
FEATURE OF
YOUR ANTENNA
IS PUTTING
IT UP WHERE
IT CAN DO
WHAT YOU
EXPECT.
RELIABLE DX —
SIGNALS EARLIEST IN
AND LAST OUT.**

ALUMINUM
Self-Supporting
Easy to Assemble
and Erect
All towers mounted
on hinged bases
Complete Telescoping
and Fold-Over
Series available

And now, with motorized options, you can crank it up or down, or fold it over, from the operating position in the house.

Write for 12 page brochure giving dozens of combinations of height, weight and wind load.

HEIGHTS MANUFACTURING CO.

In Almont Heights Industrial Park
Almont, Michigan 48003

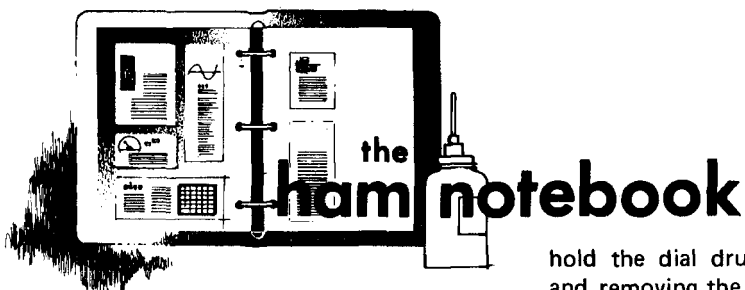

correcting mechanical backlash in the Collins 70K-2 PTO

When the 70K-2 PTO in my Collins 312B-5 remote vfo developed an annoying mechanical backlash, I decided to dig into it to see if I could fix it myself and save the \$75 or so Collins currently charges for a rebuilt PTO. Initially, I was hesitant to work on the PTO for fear of upsetting the frequency calibration, but when the problem became sufficiently annoying that I had either to fix it or replace it, I decided I had nothing to lose by trying. As it turned out, the remedy was simple and did not require disturbing any of the internal wiring of the PTO. The frequency calibration was unaltered, and the backlash was completely eliminated. The 70K-2 PTO is also used in the KWM-2, 32S-1, 32S-3, 75S-1 and 75S-3.

The symptom of the problem was that in certain areas of the PTO range, I could rock the dial back and forth up to 1 kHz without changing frequency. Of course, mechanical backlash can also be caused by a malfunctioning dial mechanism, but in this case I determined that the problem was in the PTO itself. The first thing to do is to get the PTO out in the clear where it can be easily worked on by loosening the two set screws that

hold the dial drum on the PTO shaft and removing the two mounting screws that hold the PTO rear cover to the chassis. With the 312B-5 there was sufficient slack in the wiring that it did not have to be disconnected, but this may be necessary on the other equipment. Once the PTO is dismantled from the chassis, the rear cover can be removed and slid down the wiring harness out of the way.

On either side of the PTO shaft there is a screw which extends the entire length of the tuning coil form and is threaded into the tuning coil rear cover. Turn the shaft back and forth through its entire range a few times and note how the heads of these screws work in conjunction with the special bushings and washers on the shaft to act as stops, limiting the total shaft rotation to $2\frac{1}{4}$ turns. The bushing and washers should not be removed or loosened, as they determine the end points of the tuning range. It is important to note their relationship with respect to each other and to the screw heads in order to properly reset the tuning end points when reassembling the PTO.

There is a single tiny ball bearing which is held between a dimple in the tuning coil rear cover and a dimple in the end of the tuning coil shaft. Holding the rear cover in place, remove the two screws and be careful not to lose the ball bearing when removing the rear cover.

Looking at the rear of the exposed coil tuning assembly, rotate the tuning shaft and observe how the coil core moves in and out, riding on a spiral groove cut into the shaft. The core assembly has an anti-backlash spring which rides on a groove on the inside of the form. There is a lubricant which appears to be a graphite compound used between the shaft and the core. In my unit there was an excessive build-up of this lubricant at certain places on the shaft and inside the core. This build-up was thick enough to overcome the tension of the anti-backlash spring, allowing the core to rotate instead of moving in and out, thereby causing the backlash. Turn the shaft until the core can be removed, and wipe the excess lubricant from the shaft and from inside the core. To reassemble the PTO, merely reverse the disassembly procedure.

John Becker, K9WEH

simple satellite antenna

K4GSX's article on simple stationary antennas for satellite use showed how a ground-plane antenna could be adapted to OSCAR use by slanting the driven element and using a matching section to accommodate the change of impedance.* I've been using a simple ten-meter inverted-vee antenna for OSCAR reception quite successfully since December, 1972. As can be seen in fig. 1, a tilted vertical is physically one-half of an inverted-vee or drooping doublet, but without the matching section or radials. Therefore, an inverted-vee is a double-tilted vertical fed in the center.

A dipole theoretically has a radiation resistance of approximately 72 ohms, and slanting the wires downward lowers the input impedance sufficiently for

direct connection to 52-ohm cable. Other advantages of the inverted-vee include ease of construction and erection, and the possibility of adding a balun later, if desired.

The characteristics of an inverted-vee are somewhat different than those of a

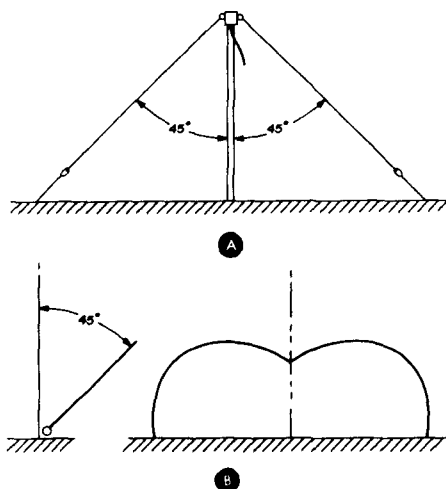

fig. 1. Diagram showing the physical characteristics of a quarter-wave tilted vertical, to that of an inverted vee. The inverted-vee in (A) uses two center fed quarter-waves. The tilted vertical in (B) in one quarter-wave, base fed.

dipole, and it is suggested for satellite communications that the wires run north and south because the radiation pattern is off the ends of the antenna. This arrangement facilitates reception since the satellite travels in a polar orbit. Because of the antenna's physical characteristics, the inverted-vee probably offers the best compromise between horizontal and vertical polarization, and, therefore, is well suited for satellite work while still meeting the four design objectives cited in the article. Although no claims are made as to the radiation pattern, it should probably be close to that of a tilted vertical.

Craig Caston, WA6PXY

*Dale Covington, K4GSX, "Simple Antennas for Satellite Communications," *ham radio*, May, 1974, page 24.

new products

two-band fm transceiver



The Comcraft Company has announced the introduction of a new all solid-state two-band, frequency-synthesized fm transceiver, the model CST-50. The CST-50 features operation on both two and 1-1/4 meters with 25-watts output and 5-kHz frequency-synthesized channel spacing. Operating modes provided include simplex, split transmit and receive, and repeater offsets of plus and minus 600 kHz, 1 MHz and 1.6 MHz.

Frequency coverage on the 220 band is from 220 to 225 MHz while on two meters it is from 142 to 149.995 MHz (to cover most MARS, CAP and CD frequencies). The frequency synthesizer is a digital type using programmable

dividers and phase-locked loops to generate the desired frequencies by reference to a single 5-MHz crystal. Two thumbwheel sets are provided for setting up either transmit and receive frequencies for non-standard repeaters or two separate repeaters when standard offsets are in use.

Additional features of the CST-50 include the use of an eight-pole 10.7-MHz crystal filter in the receiver; transmitter coverage of both bands without retuning; illuminated thumbwheel switches for night mobile work; PTT mike and mobile mount; and quality construction using epoxy-glass PC boards and vinyl-clad outer cabinet.

The CST-50 is priced at \$769.95. For more information, write to Comcraft Company, Post Office Box 266, Goleta, California 93017, or use *check-off* on page 94.

ARRL antenna book

The new 13th edition of *The ARRL Antenna Book* represents the most extensive revision this publication has received within the past 25 years. Although much of the basic information of previous editions on subjects such as radio propagation and antenna theory has been retained in early chapters of the book, all information has been carefully edited for clarity and has been supplemented with later data where modern technology has brought new knowledge.

In the later chapters some striking changes from previous editions will be noted. A large section appears on the use of the Smith chart in solving transmission-line problems. Information on cubical-quad antennas has been greatly expended. Design and construction information on log-periodic antennas has been added. Construction information on standard antennas — dipoles, Yagis and simple arrays — has been revised extensively, and new antenna types such as a 40-meter *sloper*

are described. Information on rotator and tower selection and installation have also been added.

Four new chapters appear in the 13th edition, one on antennas for restricted space, one on antennas for space communications, one on measurements and one on specialized antennas that amateur radio enthusiasts often hear about but are unable to find information on — the Beverage, discone, conical monopole, fishbone, bobtail curtain and others. From its newly designed front cover, which retains a bit of the appearance of the covers of older editions, to its completely new index at the back, this edition is packed with useful information on all types of practical antennas.

The new edition contains 336 pages and is priced at \$3.00 from HR Books, Greenville, New Hampshire 03048.

160-meter transverter



The new 160-meter transverter from Dentron Radio provides up to 100-watts input over the entire 160-meter band. This new unit, which needs only two connections to your existing ssb transceiver, requires only five-watts drive for full rated output (3.8- to 4.0-MHz input). The transverter includes a built-in power supply for 115/230 Vac, 50/60 Hz.

Also available from Dentron is their new 160 AT antenna tuner which matches any 160-meter exciter with a 50-ohm output to almost any random-length wire or existing antenna.

The 160 XV 160-meter transverter is priced at \$199.50, postpaid in the USA.

LOW COST DIGITAL KITS

NEW BIPOLAR MULTIMETER: AUTOMATIC POLARITY INDICATION

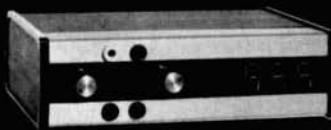

Model ES 210K

Displays Ohms, Volts or Amps in 5 ranges • Voltage from 100 Microvolts to 500 V • Resistance from 100 Milliohms to 1 Megohm • Current from 100 Nano Amps to 1 Amp . . . \$82.00 Case extra \$12.50 (Optional probe) \$5.00

40 MHz DIGITAL FREQUENCY COUNTER:

- Will not be damaged by high power transmission levels.
- Simple, 1 cable connection to transmitter's output.



ES 220K — Line frequency time base.
1 KHz resolution . . . 5 digit: \$79.50. Case extra: \$10.00
ES 221K — Crystal time base.
100 Hz resolution . . . 6 digit: \$109.50. Case extra: \$10.00

DIGITAL CLOCK:



ES 112K/124K • 12 hour or 24 hour clock: \$46.95.
Case extra: • Metal \$7.50

CRYSTAL TIME BASE:

ES 201K — Opt. addition to ES 112K, 124K or 500K
Mounts on board. Accurate to .002% . . . \$25.00

I.D. REMINDER:

ES 200K — Reminds operator that 9 minutes and 45 seconds have passed. Mounts on ES 112 or 124 board. Silent LED flash: \$10.95. Optional audio alarm \$4 extra.

Dependable solid state components and circuitry. Easy reading, 7 segment display tubes with clear, bright numerals. These products operate from 117 VAC, 60 cycles. No moving parts. Quiet, trouble free printed circuit.

Each kit contains complete parts list with all parts, schematic illustrations and easy to follow, step by step instructions. No special tools required.



ORDER YOURS TODAY:
Use your Mastercharge or
BankAmericard
Money Back Guarantee

505 1/2 Centinela • Inglewood, Ca. 90302 • (213) 674-3021

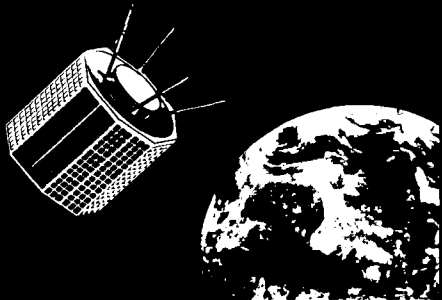

OSCAR 7 ?

432 MHz UP-LINK

TX: 144 to 432 MHz
 Varactor Tripler
 MMv432 \$75.20
 MMv432H \$112.80

ANT: 17.3 dB Multibeam
 70/MBM46 \$51.75

145 MHz DOWN-LINK

RX: 2 to 10 Meter
 Converter
 MMc144 \$53.70

ANT: 12.6 dB 8 over 8 Yagi
 D8/2M \$39.95

435 MHz TELEMETRY

RX: 435 MHz to 10 Meter
 Converter
 MMc432 \$64.45

ANT: 17.3 dB Multibeam
 70/MBM46 \$51.75

IMPROVE YOUR RECEPTION WITH KVG CRYSTAL FILTERS

XF9A	SSB 2.5 kHz BW	5 POLE	\$31.95
XF9B	SSB 2.4 kHz BW	8 POLE	\$45.45
XF9M	CW 500 Hz BW	4 POLE	\$34.25

MATCHING OSCILLATOR CRYSTALS			
XF901	8998.5 kHz	USB	\$3.80
XF902	9001.5 kHz	LSB	\$3.80
XF903	8999.0 kHz	CW	\$3.80
F-05 CRYSTAL SOCKET			50¢

Export inquiries welcome

**SPECTRUM
 INTERNATIONAL**
 BOX 1084 CONCORD
 MASSACHUSETTS 01742
 U. S. A.



The 160 AT antenna tuner is priced at \$59.95. For more information, write to Dentron Radio Company, 27587 Edgepark Drive, North Olmstead, Ohio 44070, or use *check-off* on page 94.

new signal/one

The new Signal/One CX-11 deluxe integrated station offers many new features not available on the older CX-7A. Featured in the new design is a broadband solid-state linear power amplifier with 175 watts rf output. It requires no tuning over the six amateur bands from 1.8 to 30 MHz, operates into any vswr and is capable of continuous duty at full rated output.

The new CX-11 also contains a new concept in front-end design — using doubly-balanced active fet mixers for unmatched sensitivity, blocking and cross-modulation rejection. Five bandwidths of audio selectivity are standards: 2.4, 1.5, 1.0, 0.4 and 0.1 kHz. A peak/notch filter with adjustable frequency notch depth is also included.

Also featured in the CX-11 is a built-in electronic keyer with independent speed and weight control and partial or full-dot memory. The six-digit frequency readout uses half-inch amber or red LEDs and is optimized for non-blinking, stable display. The power supply is completely self protecting — both thermal and current overload — and is IC controlled. Additional features include dual VFOs for transceive, split operation or dual receive, adjustable i-f shift, receive or transmit offset tuning, push-button spotting, adjustable rf clipping, instantaneous CW break-in, built-in wattmeter, built-in noise blanker and adjustable rf power output.

The Signal/One CX-11 is now in production at \$2600, and is distributed by Payne Radio, Box 525, Springfield, Tennessee 37172. For more information, write to Signal/One, Box 127, Franklin Lakes, New Jersey 07417, or use *check-off* on page 94.

Clegg

THE 2-METER LINE



- 146-148 MHz
- 25 WATTS OUTPUT
- CRYSTIPLEXER CONTROL

HT-146

- 144-148 MHz
- 1.5 WATTS
- 5 CHANNELS



031 POWER SUPPLY

- 13.5 VOLTS
- 6.5 AMPS
- BUILT-IN SPEAKER



and the ALL NEW. . .

FM-DX

- AMERICAN MADE
- EXTRUDED ALUMINUM CHASSIS
- ALL MODULAR CONSTRUCTION
- ALL SOLID STATE
- SPEECH PROCESSED FM
- BUILT-IN SPEAKER
- COMPACT 10.5Lx7Wx3.25H



- 143.5 - 148.5 MHz IN DIGITALLY SYNTHESIZED 5 KHz STEPS
- 30 WATT TRANSMITTER WITH HI-LO POWER SWITCH
- MEANINGFUL, BROAD RANGE S-METER
- BRIGHT NUMERIC LED FREQUENCY READ OUT
- TRANSMITTER TRACKS RECEIVER FREQUENCY
- SUPER SENSITIVE, INTERMOD FREE RECEIVER
- ACCOMODATES ANY REPEATER SPACING

ISC

Clegg DIVISION

3050 Hempland Road
Lancaster, Pennsylvania 17601

With the HAL RVD-1005, what you see is what you get.

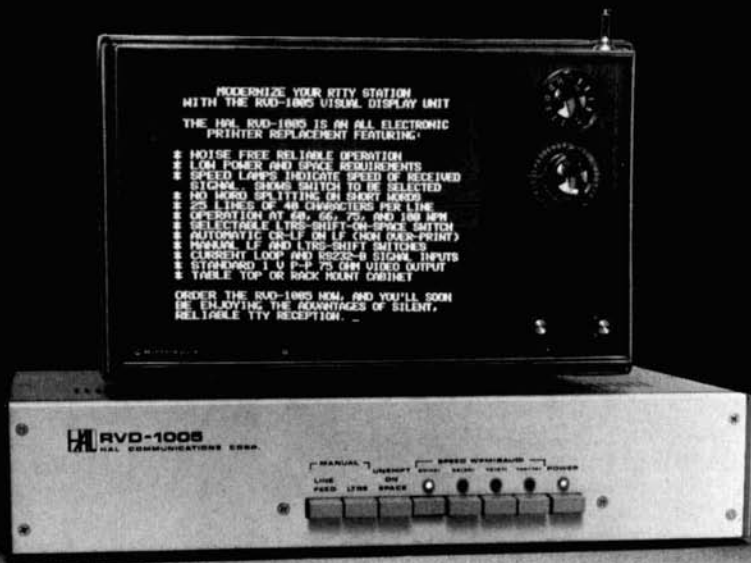

And you get more of what you expect from noiseless, trouble-free all solid-state TTY reception. The RVD-1005 converts the output of any TU into a clear, easy-to-read RTTY readout. The signal can be fed to a TV monitor* or, with slight modification, any standard TV receiver (Just imagine a 23-inch teleprinter!). It's the beginning of enjoyable TTY communications and the end of electromechanical devices with all of their maintenance headaches. The display above points out the many reasons why the RVD-1005 makes all other TTY systems seem obsolete—and it's just part of the HAL lineup of quality, state-of-the-art RTTY components for the serious amateur.

The HAL DKB-2010 dual mode keyboard is another example. It allows you to transmit TTY or Morse—TTY at all standard data rates, and CW

between 8 and 60 WPM. You also get complete alphanumeric and punctuation keys, plus 10 other function keys, a "DE—call letters" key and a "QUICK BROWN FOX..." diagnostic key. In both modes you have a three character buffer for bursting ahead (larger buffers optional); and in the CW mode you can adjust the dot-to-space ratio (weight) to your liking.

When we say what you see is what you get, you can count on getting all that and more, including quality construction throughout. So if you're into RTTY, join the ranks of amateurs the world over who are enjoying this hobby at its best—with professional gear at amateur prices from HAL—the leader in amateur RTTY equipment. Send today for the HAL products you want!

*RVD-2110 9-inch Monitor/TV shown is optional



HAL Communications Corp.
Box 365 Urbana, Ill. 61801
Telephone: (217) 359-7373

Enclosed is \$ _____ (RVD-1005 Video Unit)

\$ _____ (RVD-2110 Monitor/TV) \$ _____ (DKB-2010 TTY/CW Keyboard)

- Charge Master Charge # _____
 Charge BankAmericard # _____
 M/C Interbank # _____ Card exp. date _____
 Please send me the HAL catalog

Name _____ Address _____ Call Sign _____

City/State/Zip _____

RVD-1005 Video Unit: \$575. RVD-2110 Monitor TV: \$150. DKB-2010 TTY/CW Keyboard: \$425.

All prices include USA shipping. Add \$10 each for air shipment. Illinois residents add 5% sales tax.

Morse and RTTY from one keyboard?



Meet the two and only.

The HAL DKB-2010 Dual Mode keyboard is one of the most sophisticated products ever offered to the radio amateur. It's an all solid state keyboard that allows you to send either RTTY or CW — with more ease, more versatility than anything you've ever seen before.

In the RTTY mode, you can transmit at standard data rates of 60, 66, 75 or 100 WPM, as well as an optional 132 WPM, 100 baud. In addition to the complete alphanumeric keys, you get 17 punctuation marks, 3 carriage control keys, 2 shift keys, a break key, 2 three-character function keys, a "DE-call letters" key and a "Quick brown fox . . ." test key.

In the CW mode, you can send at speeds anywhere between 8 WPM and 60 WPM. You can also adjust dot-to-space weight ratios to your liking. For CW, you have all alphanumeric keys, plus 11 punctuation marks, 5 standard double-character keys, 2 shift keys, a break-for-tuning key, error key, "DE-call letters" key, plus

2 three-character function keys. Output interfacing is compatible with cathode keying or grid-block keying. A side tone oscillator and built-in speaker allow you to monitor your signal — with adjustable volume and pitch controls.

The DKB-2010 also has a three-character memory buffer which operates in either the RTTY or CW mode, allowing you to burst type ahead without losing characters. A 64-character memory buffer is also available as an option. Key function logic in either mode is governed by LSI/MOS circuitry. All key switches are computer grade.

The DKB-2010 is available assembled or in kit form. Should you choose the kit, you'll find construction easy — the unit consists of three assemblies: power supply board, logic PC board, keyswitch PC board, and pre-assembled wiring harness.

Any way you look at it — as an easy-to-build kit, a complete assembly, as a CW keyboard, or an RTTY keyboard, the HAL

DKB-2010 is a real breakthrough for every amateur. It adds a whole new dimension to the exciting world of amateur radio. Once you've used the DKB-2010, you'll wonder how you ever got along without it!

Prices: \$425 Assembled;
\$325 Kit



HAL Communications Corp.
Box 365, Urbana, Ill. 61801
Telephone: (217) 359-7373

- Enclosed is \$ _____ (Assembled)
\$ _____ (Kit)
Call letters _____
 Charge Master Charge # _____
 Charge BankAmericard # _____
M/C Interbank # _____
Card Exp. date _____
 Please send me the HAL catalog.

Name _____

Address _____

City/State/Zip _____

All prices include U.S.A. shipping.
Add \$10 for air shipment.
Illinois res. add 5% sales tax.

SUPER CW FILTER

The IMPROVED CWF-2BX offers RAZOR SHARP SELECTIVITY with its 80 Hz bandwidth and extremely steep sided skirts. Even the weakest signal stands out.

Plugs into **any** receiver or transceiver. Drives phones or connect between receiver audio stage for full speaker operation.

- Drastically reduces all background noise
- No audible ringing
- No impedance matching
- No insertion loss
- 8 pole active filter design uses IC's
- Bandwidth: 80 Hz, 110 Hz, 180 Hz (selectable)
- Skirt rejection: at least 60 db down one octave from center frequency for 80 Hz bandwidth
- Center frequency: 750 Hz
- 9 volt transistor battery not included.

- 400 Hz or 1000 Hz center frequency available add \$3.00.

IMPROVED CWF-2BX, assembled \$22.95
 CWF-2, PC board, includes 4 position selectivity switch \$15.95
 CWF-2, kit \$13.95



A STACK FOR CW MEN

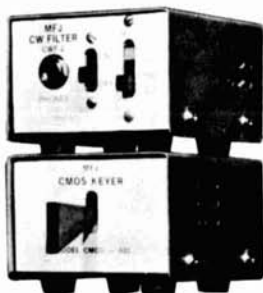

4 x 3 1/4 x 2 3/16 inch

Dealer Inquiries Invited

CMOS ELECTRONIC KEYSER

Feature for feature the CMOS-440RS gives the most for your money: • State of the art design uses digital CMOS ICs and NE555 sidetone • Built-in key with adjustable contact travel • Sidetone and speaker • Adjustable tone and volume • Jack for external key • 4 position switch for TUNE, OFF, ON, SIDETONE OFF • Two output jacks: direct relay, grid block keying • Uses 4 penlight cells (not included) • Self completing dots and dashes • Jam proof spacing • Instant start with keyed time base • Perfect 3 to 1 dash to dot ratio • 6 to 60 WPM • Relay rated 250 VDC, 1 1/2 amp, 30 VA

CMOS-440RS, Deluxe \$34.95

Write for FREE catalog and CW filter test reports. Please include \$1.50 per unit for shipping and handling. Money back if not satisfied. One year UNCONDITIONAL guarantee.



MFJ Enterprises, P. O. Box 494, Miss. State, MS 39762, (601) 323-5869

— CLEAN SIGNAL —
 — ALL CHANNELS —

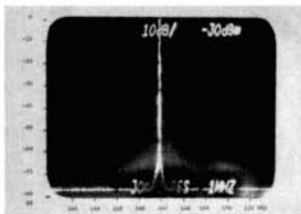

ACTUAL SPECTRUM ANALYZER PHOTOGRAPH OF AN RF SYNTHESIZED RADIO

ONLY RP GIVES YOU BOTH PLUS

- SUPER ACCURACY (.0005%)
- FULL 2M FM COVERAGE

144-148 MHz

WORKS WITH YOUR FINE AMATEUR OR COMMERCIAL GRADE RADIO

MFA-22 SYNTHESIZER

SEND FOR FULL DETAILS

RP Electronics

810 DENNISON DRIVE
 BOX 1201
 CHAMPAIGN, IL 61820
 Phone: 217-352-7343



the BIG ONE!

NEW IMPROVED

INSTANT-WELD Adhesive

Now a choice of 4 formulas . . . and in Big 1900 drop application container.

SAVE BIG only \$8.95

(less than 1/2¢ an application)

ORDER FROM YOUR ONEIDA DISTRIBUTOR OR DIRECT FROM US.



ONEIDA ELECTRONIC MFG. INC.

P. O. Box 678 — Dept. 761-D
 Meadville, Pa. 16335

There Is a Difference In Quartz Crystals

Space age communication equipment demands a crystal that meets all standards of technical advancement. Crystals that were acceptable some years ago do not meet present day specifications. As a general rule, your crystal must be selected from the best quartz . . . (no throw off cuts). Tight tolerances demand selected angles of cut. The x-ray is important in making this selection. The crystal should be preaged with stress cycling. It should be checked for frequency change vs temperature change. It must be checked for optimum spurious response. It should be calibrated to frequency with the correct oscillator. International Crystals are manufactured to meet today's high accuracy requirements. That's why **we guarantee all** International crystals against defective materials and workmanship for an unlimited time when used in equipment for which they were specifically made.

WRITE FOR CATALOG



CRYSTAL MFG. CO., INC.
10 NORTH LEE
OKLAHOMA CITY, OKLA. 73102

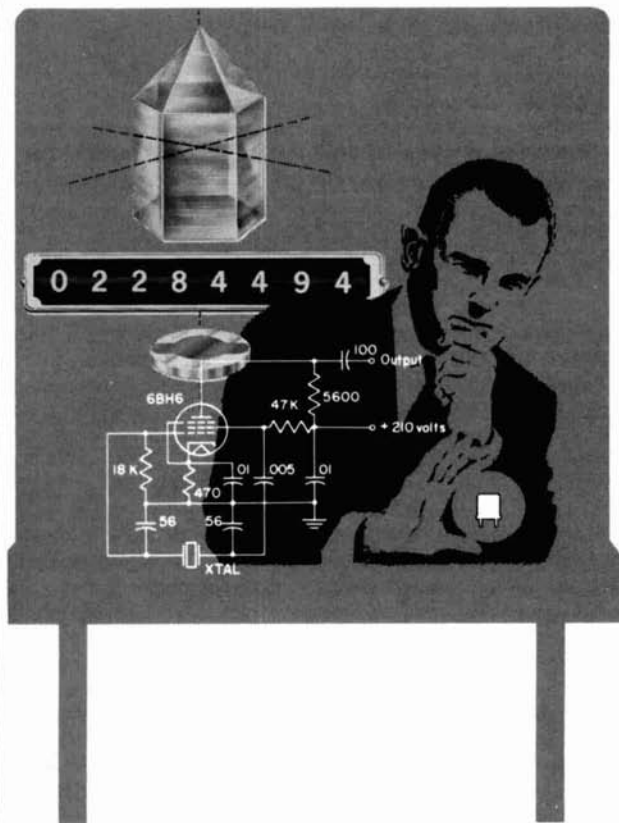

SAROC HAWAIIAN HOLIDAY

including

SAROC's First Hawaiian Convention

Spend 8 fabulous days in exciting Hawaii
on SAROC's Hawaiian Holiday

Your holiday includes:

- Attendance at the SAROC Hawaiian Convention
- 3 nights at the Sheraton Waikiki on famous Waikiki Beach
- 4 nights at Del Webbs exotic Kuilima on Oahu's beautiful north shore
- Optional visit to the other islands
- Round trip air transportation from Los Angeles or San Francisco on Western Airlines
- Connecting flights from selected Eastern and Mid-Western cities via United Airlines
- Leave June 1, 1975 — Return June 8, 1975

*Combine your favorite hobby with beautiful Hawaii
and you have a vacation you'll never forget.*

All travel arrangements by Del Webb World Travel Co.

for further details write

SAROC

Box 945

Boulder City, Nev. 89005

GIANT SAVINGS!



GTX-600 6-Meter FM
100 channels, 35 watts
WAS \$309.95

NOW
\$219⁹⁵
(Incl. 52.525 MHz)



GTX-100 1 1/4-Meter FM
100 channels, 12 watts
WAS \$309.95

NOW
\$219⁹⁵
(Incl. 223.5 MHz)



GTX-200 2-Meter FM
100 channels, 30 watts
WAS \$299.95

NOW
\$199⁹⁵
(Incl. 146.94 MHz)



GTX-10 2-Meter FM
10 channels, 10 watts
WAS \$239.95

NOW
\$169⁹⁵
(Incl. 146.94 MHz)



GTX-2 2-Meter FM
10 channels, 30 watts
WAS \$299.95

NOW
\$189⁹⁵
(Incl. 146.94 MHz)

CLIP OUT AND ORDER NOW!



GENAVE, 4141 Kingman Dr., Indianapolis, IN 46226

HR

HEY, GENAVE! Thanks for the nice prices! Please send me:

- | | |
|--|---|
| <input type="checkbox"/> GTX-600 @ \$219.95 \$ | <input type="checkbox"/> Lamda/30 2-M Base Antenna @ \$39.95 \$ |
| <input type="checkbox"/> GTX-200 @ \$199.95 \$ | <input type="checkbox"/> Lamda/4 2-M Trunk Antenna @ \$29.95 \$ |
| <input type="checkbox"/> GTX-100 @ \$219.95 \$ | <input type="checkbox"/> TE-1 Tone Encoder Pad @ \$59.95 \$ |
| <input type="checkbox"/> GTX-2 @ \$189.95 \$ | <input type="checkbox"/> PSI-9 Port. Power Package @ \$29.95 \$ |
| | (less batteries) |
| <input type="checkbox"/> GTX-10 @ \$169.95 \$ | <input type="checkbox"/> PS-1 AC Power Supply @ \$49.95 \$ |
- and the following standard crystals @ \$4.25 each: _____ \$

Non-standard crystals \$4.25 each; allow 8 weeks delivery.
For factory crystal installation add \$8.50 per transceiver.

Sub-Total \$ _____ Ind. residents add 4% sales tax: _____
Cal. residents add 6% sales tax: _____ **TOTAL: \$** _____

All orders shipped post-paid within continental U.S. For C.O.D., Include 20% Down.

NAME _____ AMATEUR CALL _____

ADDRESS _____ CITY _____ STATE & ZIP _____

Payment by: Certified Check/Money Order Personal Check C.O.D.

Note: Orders accompanied by personal checks will require about two weeks to process.

20% Down Payment Enclosed, Charge Balance To:

BankAmericard # _____ Expires _____

Master Charge # _____ Expires _____ Interbank # _____

Prices and specifications subject to change without notice.

The Argonaut has become a *Classic* in QRPp



Argonaut



Model 405 Linear

The sustained demand and the enthusiastic comments from happy Argonaut owners are music to our ears. We designed this portable pair to be fun, and your response tells us that it's just what you've been looking for. The Argonaut and its companion, the 405 Linear, are here to stay—thanks to you.

Argonaut, Model 505	\$319.00
Linear, 100 Watt, Model 405	159.00
Power Supply for 505 only, Model 210	27.50
Power Supply for 505 and 405, Model 251	79.00

TEN-TEC
INCORPORATED
SEVIERVILLE, TENNESSEE 37862

PUBLIC AUCTION SURPLUS RADIO EQUIPMENT

Saturday, February 15, 1975, 1:00 p.m. E.S.T.

The New York State Thruway Authority will sell at public auction a variety of surplus electronic equipment. Items include General Electric High Band, 120 volt transceivers; Western Electric 100F and 107AW amplifiers; General Electric and Motorola remote control consoles, Conelrad receivers hand sets and hang up boxes, four dispatcher consoles with all equipment; random cable, terminal boards, desk mikes, test equipment.

A complete list of equipment available may be obtained from the Purchasing Director, New York State Thruway Authority, 200 Southern Blvd., Albany, N.Y. 12209. The Auction will be held in Albany at Thruway Headquarters, 200 Southern Blvd., adjacent to Thruway Interchange 23.

New York State
Thruway
Authority



TOUCH-TONE DECODER

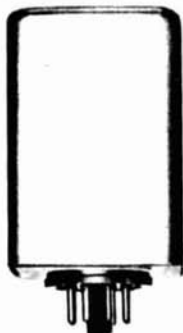

- Dual tone decoder decodes one Touch-Tone digit.
- Available for 1, 2, 3, 4, 5, 6, 7, 8, 9, 0, #, * and other dual tones 700-3000 Hz.
- Latch and reset capability built-in.

- COR control built-in.
- Relay output SPST 1/2-amp.
- Octal plug-in case.
- Compact 1-3/4" square, 3" high.
- Free descriptive brochure on request.

T-2 Touch-Tone Decoder ... \$39.95 PPD.
Specify digit or tone frequencies.
(Include sales tax in Calif.)

**PALOMAR
ENGINEERS**

BOX 455, ESCONDIDO, CA 92025



Vhf engineering



— DIV. of BROWNIAN ELECTRONICS CORP. —

320 WATER ST. P.O. BOX 1921 BINGHAMTON, NY 13902 607-723-9574

MINI-CATALOG 1975

THE WORLD'S MOST COMPLETE LINE OF VHF—FM KITS AND EQUIPMENT

CD1 Kit	10 channel receive xtal deck w/diode switching	\$ 6.95
CD2 Kit	10 channel xmit xtal deck w/switch and trimmers	\$14.95
COR2 Kit	complete COR with 3 second and 3 minute timers	\$19.95
SC2 Kit	10 channel auto-scan adapter for RX	\$19.95
TX144 Kit	exciter—1 watt—2 meters	\$29.95
TX220 Kit	exciter—1 watt—220 MHz	\$29.95
TX432 Kit	exciter— NEW —432 MHz	coming soon
RX144/220 F Kit	140-170 or 210-240 MHz rcvr w/8 pole cer 455 filter	\$65.95
RX144/220 C Kit	140-170 or 210-240 MHz rcvr w/2 pole 10.7 xtal filter	\$69.95
RX432 C Kit	NEW —432 MHz receiver	coming soon
HT144 B Kit	2 meter—2w—4 channel—hand held xcvr	\$129.95
PA1501H Kit	2 meter pwr amp—15w—compl. kit w/SS switching	\$49.95
PA2501H Kit	similar to above—24w	\$59.95
PA144/15 Kit	similar to PA1501H less case, connectors and switching	\$39.95
PA144/25 Kit	similar to above—25w	\$49.95
PA220/15 Kit	similar to PA144/15 for 220 MHz	\$39.95
PA432/10	NEW —similar to PA144/15 except 10w and 432 MHz	coming soon
PA4010H Kit	10w in—40w out—relay switching	\$59.95
PA110/10	10w in—110w out 2 meter amp	factory wired \$179.95
PA110/30	30w in—110w out 2 meter amp	factory wired \$149.95
PS3 Kit	power supply regulator card	\$ 8.95
PS12C Kit	12 amp—12 volt regulated power supply w/case	\$69.95
PS24C Kit	24 amp—12 volt regulated power supply w/case	\$99.95
RPT144	NEW —15 watt—2 meter repeater	factory wired \$595.95
RPT220	NEW —15 watt—220 MHz repeater	factory wired \$595.95
RPT432	NEW —10 watt—432 MHz repeater	coming soon

Repeaters are available in kit form—write for prices

ORDER FORM

ITEM	PART #	DESCRIPTION	PRICE	EXTENSION

NAME _____ TOTAL _____
 ADDRESS _____ SHIPPING _____
 CITY _____ NYS RESIDENTS-SALES TAX _____
 STATE _____ ZIP _____ TOTAL ENCLOSED _____

300 MHz PRESCALER MODEL PD-301

Model PD 301 is a 300 MHz. prescaler designed to extend the range of your counter 10 times. This prescaler has a built-in preamp with a sensitivity of better than 50 mv at 150 MHz, 100 mv at 260 MHz, and 175 mv at 300 MHz. The 95H90 scaler is rated at typical 320 MHz. To insure enough drive for all counters, a post amp. was built-in.

The prescaler has a self contained regulated power supply. The PD 301 is supplied without power supply if desired (input 50 Ohms) (output Hi Z). The PD 301 has been tested on the following counters: Heath Kit 1B101 - Heath Scientific 105 - Monsanto 105A - Miida - Regency - Beckman - Hewlett - Packard 524B - and many home built. In short to this date we do not know of any counter that the PD 301 has failed to work well with. All prescalers are shipped in a 4" x 4" x 1 1/2" cabinet all wired and tested.



PD 301K Kit With Power Supply **\$43.50**

PD 301 Complete Unit With
Power Supply **\$55.50**

Include \$1.50 to cover postage and insurance.
Shipped Same Day Order Received

K-ENTERPRISES

1401 N. Tucker Shawnee, Okla. 74801



**DON'T MISS THAT
CW QSO!!!**

**15 WATTS
FULL
BREAK-IN**



CW • TRANSMITTER MODEL 50

- Built-in Antenna Relay
- 160, 80, or 40M Plug-in Coil
- Crystal Control
- Zener Regulated Chirpless Keying
- Clean Output - "T" Network
- Built-in 115 VAC Supply

MODEL 50K - BASIC KIT \$39.95

ADD-ON OPTIONS: SIDETONE (200-21K)..... \$ 5.95
KEYER (200-22K)..... \$ 13.95

MODEL 50W - BASIC WIRED \$49.95

MODEL 50WS (WITH SIDETONE) \$59.95

MODEL 50WK (WITH KEYER) \$69.95

MODEL 50WSK (WITH SIDETONE & KEYER) \$79.95

ORDER DIRECT OR WRITE FOR BROCHURE
AND NAME OF NEAREST DEALER.

MARAIC

PHONE: (814) 432-3647
BOX 185-A • FRANKLIN, PA. 16323

2 METER FM

PORTABLE
PLEASURE
from ERICKSON . . .
SRC-146A SPECIAL WITH

- Charger
- "Stubby" antenna
- Leather case
- Ni-Cads
- 94/94, 34/94 and one channel of your choice

\$369 List
-50 Package Discount

\$319 Prepaid - Cashiers
Check or M.O.

plus ICOM/TPL/TEMPO/
KENWOOD/CUSHCRAFT/LARSEN/
ASP/SBE



ERICKSON COMMUNICATIONS

4135 Main Street (New Location)
Skokie, IL 60076 (312) 677-2161
Hours: 9-4:30 M-S; 6:30-9 M, Th, F

high accuracy CRYSTALS

for over 30 years



ONE OF A MILLION...

Commercial or Amateur Use



Write for Free Catalog

SAVOY ELECTRONICS, INC.

P.O. Box 5727 Fort Lauderdale, Florida 33310

Tel: 305-563-1333 or 305-947-9925

NASEM

HAM/HOBBY/EXPERIMENTER GRADE
SEMICONDUCTORS

- 24 HOUR COD-PHONE ANSWERING SERVICE
- OUR DATA/APPLICATION SHEET ENCLOSED WITH EACH TYPE SHIPPED
- EVERY UNIT 100% PARAMETER AND FUNCTION TESTED TO OUR GUARANTEED LIMITS ON THE SAME FAIRCHILD COMPUTER-TYPE HIGH SPEED TESTER USED BY MAJOR SEMI COMPANIES.

COMMUNICATIONS INTEGRATED CIRCUITS

IC Type	Description	Case	Price ea.
NA555	Versatile Timer	8-DIP	0.99
NA555-2	Dual Timer	16-DIP	1.55
NA370	AGC/Squelch/VOX	10-T05	1.20
NA371	Versatile RF/IF	10-T05	1.29
NA3018	4-Trans. Array	12-T05	0.89
NA3026	Dual Diff. Array	12-T05	0.99
NA3086	5-Trans. Array	14-DIP	0.45
NA3036	Dual Darlington	10-T05	0.75
NA1595	Analog Multiplier	14-DIP	1.90
NA8038	VCO/Sine/Sq./Tri.	14-DIP	4.50
NA1596	Bal. Mixer/Mod.	10-T05	1.20
NA376	Voltage Reg., Pos. Low Stdby	8-DIP	1.25
NA723	Voltage Reg., Pos./Neg.	10-T05	0.99
NA741	Op. Amp	8-DIP	0.45
NA1303	Stereo Preamp	14-DIP	0.99
NA1304	Stereo Multiplex Decoder	14-DIP	1.20
NA2111	FM IF Strip/Quad. Detector	14-DIP	2.25
NA3075	FM IF Strip/DET./Preamp	14-DIP	2.45

SPECIAL — TRANSISTOR BAGS

IC Type	Description	Case	Price ea.
2NA2222	NPN Trans., Bag of 12	TO18	2.00
2NA2907	PNP Trans., Bag of 12	TO18	2.00
2NA3904	NPN Trans. Plastic, Bag of 20	TO92	3.00
2NA3906	PNP Trans. Plastic, Bag of 20	TO92	3.00
2NA930	NPN Low Noise, Low Power, Bag of 12	TO18	3.00

RADIO TRANSMITTER ON A CHIP!

- OSCILLATOR • BUFFERS • MODULATOR •
 - CONTROLLED POWER OUTPUT STAGE •
- NA2000 100mW AM on 10 Meters 9.95
NA2001 250mW AM on 10 Meters 14.95
in stud mount package
- Both types usable at reduced output at 6 Meters and above. Requires external crystal and 2 tuned circuits. With Data/applications.

TERMS:

Prepaid U.S. orders over \$10.00, we pay shipping.
Prepaid U.S. orders under \$10.00, add \$1.00 chg.
Prepaid Foreign orders over \$10.00, add postage.
Prepaid Foreign orders under \$10.00, add \$1.00 plus postage.
COD U.S. orders over \$10.00, add \$1.50 chg.
COD U.S. orders under \$10.00, add \$2.50 chg.
No Foreign COD orders.
California residents add 6% sales tax.
Confused? Please read again before ordering.

NASEM, Box AI, Cupertino, Ca. 95014

COD-PHONE

(408) 867-5900

AUTOMATIC RECORDER 24 HOUR COD TELEPHONE ORDER SERVICE

1. Name & Full Street Address (NO P. O. Boxes) Include ZIP
2. Your telephone number, including area code.
3. Your Order - Type, Price, Quantity.

DYCOMM for RF POWER



ECHO III REPEATER



MODEL 34 WATTMETER



A4950



A8949

A COMPLETE LINE OF FM AMPLIFIERS

model — power output — gain — price

6 METER FM		2 METER FM	
A4950 - 50W - 10db - \$183.	MODEL C - 25W - 4db - \$69.	A4960 - 50W - 8db - \$192.	MODEL D - 50W - 7db - \$99.
A8949 - 100W - 10db - \$270.	SUPER D KIT - 80W - 3.5db - \$60	450 - UHF	MODEL DS - 80W - 3.5db - \$139.
MODEL 25 - 30W - 7db - \$167.	MODEL E - 25W - 10db - \$80.	MODEL 30 - 30W - 9db - \$194.	SUPER E KIT - 40W - 11db - \$60.
MODEL 30 - 30W - 9db - \$194.	MODEL ES - 40W - 11db - \$115.	MODEL 70 - 70W - 6db - \$255.	10 - 100W - 7db - \$209.
OTHER PRODUCTS	1-10 - 100W - 14db - \$226.	ECHO III FM REPEATER - \$949.	35 - 100W - 4db - \$185.
MODEL 34 WATTMETER - \$70.			



DYNAMIC

COMMUNICATIONS

948 AVE. "E" P.O. BOX 10116
RIVIERA BEACH, FLA. 33404
(305) 844-1323

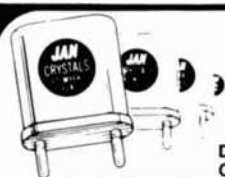

For FREQ. STABILITY

Depend on JAN Crystals.
Our large stock of quartz

crystal materials and components assures Fast Delivery from us.

CRYSTAL SPECIALS

2-METER FM for most Transceivers ea. \$3.75
144-148 MHz — .0025 Tol.

Frequency Standards
100 KHz (HC 13/U) 4.50
1000 KHz (HC 6/U) 4.50

Almost all CB Sets, Tr. or Rec. 2.50
(CB Synthesizer Crystal on request)

Any Amateur Band in FT-243 1.50
(80-meter, \$3.00 - 160-meter not avail.) 4 for 5.00
For 1st class mail, add 20¢ per crystal. For Airmail, add 25¢. Send check or money order. No dealers, please.



Division of Bob Whan
& Son Electronics, Inc.
2400 Crystal Drive
Ft. Myers, Florida
33901

All Phones
(813) 936-2397

Send 10¢ for new catalog with 12 oscillator circuits and lists of frequencies in stock.

THE ULTIMATE IN SSTV EQUIPMENT

ANNOUNCING THE SEEC HCV-3KB SLOW SCAN TV KEYBOARD

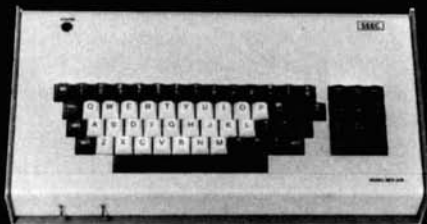

Announcing another first from the company and the designer of the world famous HCV-1B SSTV Camera and the HCV-2A SSTV Monitor, now the HCV-3KB Slow Scan TV Keyboard. This is the first commercially made SSTV Keyboard and it is built with the same quality as all SEEC/THOMAS equipment. We will not attempt to list all the features of the HCV-3KB here and we suggest that you write for full specifications. For those that are not familiar with SSTV Keyboards, the HCV-3KB eliminates the need for a menu board or other number/letter set-up arrangements which is very time consuming to set-up a meaningful text by arranging letters one at a time, by hand on a board or other surface. It also "frees up" the SSTV camera for other uses, such as live shots of the operator or other subject matter. Simply type out the message you wish to send. U. S. Patent #DD-033469.

BASIC SPECIFICATIONS

- 30 Characters Per SSTV Frame. 6 Characters Horizontally and 5 Characters (lines) Vertically. Special 35 Characters per frame available.
- Meets all standard accepted SSTV specifications.
- Positive-Negative Color (Video) Reversal.
- 1/4 & 1/2 Frame Rates.
- 4 Shade Gray Scale Generator.
- Dual Fast & Slow Scan RF & Video Outputs (Special-Optional). Later mod kit to be available for Fast-Scan & RTTY.
- Plug-In Printed Circuit Board-Gold Flashed Edge Connector.
- ICs, Op Amps, Transistors in Plug-In Sockets.
- Built-In 115/230 V 60 Hz Power Supply.
- Special 16 1/2" x 8 1/2" x 3 3/4" Aluminum Cabinet-Black & White or Optional 2 tone Gray or Blue and White - Specify.
- Special Introductory Cash With Order Price: **\$455.00**. Regular Price \$495.00. Five Ways to Purchase: Cash, C.O.D. (20% Deposit), Mastercharge, BankAmericard, SEEC Financing Plan (up to 36 months). Note: All Credit Cards Pay Regular Price of **\$495.00**. All prices F.O.B. Hendersonville, Tn. Standard 1 year warranty.

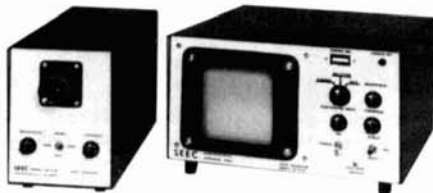

ALSO AVAILABLE FROM SEEC

HCV-1B SSTV Camera	(Reg. \$475.00)	\$452.00
HCV-1B SSTV Camera with ALC	(Reg. \$515.00)	\$492.00
HCV-2A SSTV Monitor with 2 CRT Filters	(Reg. \$425.00)	\$398.00
HCV-2B SSTV Monitor with Built-In Fast Scan Viewfinder	(Reg. \$520.00)	\$493.00
HCV-70FSVFK Fast Scan Viewfinder Modification Kit for 70 & 70A Monitors		\$69.95
Sony TC110A Cassette Recorder	Factory installation	\$37.50 additional.
Heavy Duty Camera Tripod		\$134.95
		\$34.95

A complete line of Camera and Monitor accessories are available — please write for current prices and delivery. Five Ways to Purchase: Cash With Order, C.O.D. (20% Deposit), Mastercharge, BankAmericard, SEEC Financing Plan (up to 36 months). Note: All Credit Cards Pay Regular Price shown. All prices are F.O.B. Hendersonville, Tn. Call or write us for complete specifications on any of our equipment or to be put on our mailing list. We have a 24 hour telephone answering service to better serve you, plus on the air technical assistance from the designer, WB4HCV (Jim). Two locations to better serve you. Our main Plant at 138-B Nauta-Line Dr., and our lab at 218 Tyme Bay Dr., Hendersonville. Complete 80-2 meter operation from either location. Drop in to see us if you are ever near Nashville, TN.

SUMNER ELECTRONICS & ENG. CO., INC.

P. O. BOX 572

138-B NAUTA-LINE DRIVE HENDERSONVILLE, TENNESSEE 37075

TELEPHONE: 615-824-3235

NEW! NEW! NEW! DELUXE P.C. KEYER



TTL or
C-MOS

*The keyer you can't afford
not to buy!*

In either a 5 volt TTL or a 9 volt C-MOS version this new module type IC keyer can be easily adapted to your own custom package or equipment.

Versatile controls allow wide character weight variation, speeds from 5 to 50 w.p.m. plus volume and tone control.

Solid-state output switching saves power, eliminates all those annoying relay problems and is compatible with both grid block and solid-state circuitry.

With its side-tone monitor and 90 day warranty the Data Signal PC Keyer is the one for you.

DELUXE RECEIVER PREAMPS

Specially made for both OLD and NEW receivers. The smallest and most powerful single and dual stage preamps available. Bring in the weakest signals with a Data Preamp.

FREQ (MHz)	USE	STAGES	DELUXE PREAMPLIFIER			
			GAIN	dB		
14, 21 or 28	HIGH FREQ	SINGLE	25	2	\$10.50	\$13.50
		DOUBLE	48	2	\$20.50	\$26.50
28 to 30	OSCAR SPECIAL	SINGLE	25	2	\$12.50	\$15.50
		DOUBLE	48	2	\$24.50	\$30.50
50 to 54	6 METER	SINGLE	25	2	\$10.50	\$13.50
		DOUBLE	48	2	\$20.50	\$26.50
108 to 144	VHF AIRCRAFT	SINGLE	20	2.5	\$ 9.50	\$12.50
		DOUBLE	40	2.5	\$18.50	\$24.50
135 to 139	SATELLITE	SINGLE	20	2.5	\$ 9.50	\$12.50
		DOUBLE	40	2.5	\$18.50	\$24.50
144 to 148	2 METER	SINGLE	20	2.5	\$ 9.50	\$12.50
		DOUBLE	40	2.5	\$18.50	\$24.50
146 to 174	HIGH BAND	SINGLE	20	2.5	\$ 9.50	\$12.50
		DOUBLE	40	2.5	\$18.50	\$24.50
220 to 225	1 1/4 METER	SINGLE	18	2.5	\$ 9.50	\$12.50
		DOUBLE	35	2.5	\$18.50	\$24.50
225 to 300	UHF AIRCRAFT	SINGLE	15	2.5	\$ 9.50	\$12.50
		DOUBLE	30	2.5	\$18.50	\$24.50
1 thru 30	HF BROADBAND		19-36	3	—	\$17.95

Write today for complete details

Data Signal, Inc.

Successor to Data Engineering, Inc.

2212 Palmyra Road
Albany, Ga. 31701
912-435-1764

500 MHZ PRESCALER



3" x 4" x 1 1/2"

EXTEND YOUR COUNTER TO 500 MHZ !!!

Can be used with Any counter capable of 5Mhz.

- *F_{MAX} greater than 500Mhz.
- *HIGH INPUT SENSITIVITY: less than 150mv. needed at 500 Mhz - overload protected
- *HIGH INPUT IMPEDANCE: 500 ohms
- *OUTPUTS: +10 and +100 TTL compatible
- *INCLUDES POWER SUPPLY

ORDER NOW!

PS-K kit \$ 89.00
PS-A wired and tested \$109.00
plus \$ 85 postage

Calif. residents add 6% sales tax

LEVY ASSOCIATES

P.O. Box 961 R
Temple City, Calif. 91780

SPACE SAVER TOWERS & MASTS

CZ series towers, cranks up, installs without guy wires. New lacing design creates greater strength.

Mini and Magna rotating masts . . . high strength galvanized tubing, self supporting crank-up.

For complete details and prices please check your local dealer or write
Certified Welders L.A. City License #634

CRISTAO TOWER CO.

P.O. Box 115, Hanford, California 93230

GROTH-Type

COUNTS & DISPLAYS YOUR TURNS



- 99.99 Turns
- One Hole Panel Mount
- Handy Logging Area
- Spinner Handle Available

PRICES POST PAID
TC 2 — \$7.00
TC 3 — \$7.50
Spinner (-S) — \$1.00
Add \$0.75 for Air or UPS

Case: 2x4"; shaft 1/4"x3"
Model TC2: Skirt 2 1/8"; Knob 1 1/2"
Model TC3: Skirt 3"; Knob 2 1/2"

R. H. BAUMAN SALES

P.O. Box 122, Itasca, Ill. 60143

THE CT-1024 TERMINAL SYSTEM



ALL ELECTRONIC RTTY—

Not just a display or a keyboard replacement

Our revolutionary CT-1024 makes it possible to build a completely electronic RTTY system. The CT-1024 plus a video monitor, or TV set with a video input jack, is all you need to compose, transmit and receive. Interfaces with your transmitter at a standard RS-232 interface level.

It works like this—You type the message to be transmitted, plus any comments if you wish, onto the screen. You can use our KBD-2 keyboard, or any other ASCII encoded keyboard that you might have available. The characters are stored in a 1,024 bit static semiconductor memory. The format is two pages, or frames, of 16 lines having up to 32 characters per line. When you are finished, you push the "READ" button on the CT-1024. This causes the cursor to advance through the material on the screen one character at a time and place its ASCII code in the UART portion of the terminal. The UART converts the parallel code to a serial format and passes it on to the interface for transmission. The standard rate is

110 Baud, but 220, 300, 600 and 1200 are available as options.

When you receive, the process is reversed. The UART takes the incoming serial data, converts it to a parallel ASCII code and places the information in memory. The message is displayed on the screen at the same time.

You can also use the CT-1024 with a modem as a time share computer terminal or directly with a CPU as an input device.

Please note that this is a kit. It does not include a cabinet, or chassis. This system is not for the "plug it in and transmit" crowd. This system is designed for the serious RTTY operator who builds his equipment and wants to use the latest techniques. You will need the first three items below for a system. You may, or may not need the keyboard and power supply, depending on what other equipment you already have on hand.

#CT-2024 Terminal System Kit—less cabinet or power supply	\$175.00 PPd
#CT-E Screen Read Plug-in Card Kit	\$ 17.50 PPd
#CT-S Serial Interface Kit (UART)	\$ 44.95 PPd
#CT-M Manual Cursor Control Plug-in Card Kit	\$ 11.50 PPd
#CT-P Power Supply for CT-1024—115-230 Volt Primaries	\$ 15.50 PPd
#KBD-2 Keyboard Kit—53 Keys	\$ 39.95 PPd

FREE—1975 Catalog—Circle our number on the "Bingo" card.



SOUTHWEST TECHNICAL PRODUCTS CORPORATION
219 W. RHAPSODY
SAN ANTONIO, TEXAS 78216

(512) 344-3140

DuPage FM

WILL NOT BE UNDERSOLD!

MOTOROLA

MOTRACS: U43HHT 152-172 MHz, 30 W out, solid state receiver. With accessories.

Single frequency \$240.00

Two freq. tx (if available) \$260.00

U63HHT 152-172 MHz, 80 W out, solid state receiver. With accessories. Two freq. \$350.00

(Motrac quantities limited; first come, first served.)

MOTORCYCLE RADIOS: D33AAT 152-172 MHz, 10 W out, solid state power supply. Front mount, less mike \$ 40.00

T33AAT 152-172 MHz, 10 W out, solid state power supply, rear mount with head and cables \$ 45.00

PORTABLES: H21AAC-1½ W out, dry battery supply (less battery) 30-50 MHz \$ 25.00

P31AAC 5 W out, dry battery supply (less battery) 30-50 MHz \$ 30.00

GENERAL ELECTRIC

TPL's (TRANSISTORIZED PROGRESS LINE): Solid state receiver, exciter; 3 or 4 tubes in transmitter.

100 W out, 30-50 MHz, two freq. with NOISE BLANKER. Less accessories. RE72JB3 \$300.00

100 W out, 30-50 MHz less accessories, TE72JA3 \$225.00

80 watts output in the 152-173 mc band, less accessories \$200.00

TPL accessories \$ 35.00

PROGRESS LINES: 6/12 volt vibrator supply.

MA/E 13N 30 W out, 30-50 MHz, with accessories for trunk mount. FULLY NARROW-BANDED \$ 65.00

FA/E 16N 60 W out, 30-50 MHz, with accessories for front mount. FULLY NARROW-BANDED \$ 85.00

MA/E16 60 W out, 30-50 MHz, w/accessories for trunk mount \$ 90.00

MA/E33 30 W out, 152-172 MHz, w/accessories for trunk mount \$ 75.00

PROGRESS LINES: 12 volt transistor supply.

MT-42N 15 W out, 450-470 MHz, with accessories for trunk mount (narrowbanded) \$ 60.00

MT-13N 30 W out, 30-50 MHz, with accessories for trunk mount, FULLY NARROW-BANDED \$100.00

MT-16N 60 W out, 30-50 MHz, with accessories for trunk mount. FULLY NARROW-BANDED \$130.00

Quantities limited.

Send check or money order today.

DuPAGE FM INC.

P. O. Box 1, Lombard, IL 60148

(312) 627-3540

TERMS: All items sold as is. If not as represented return for exchange or refund (our option) shipping charges prepaid within 5 days of receipt. Illinois residents must add 5% sales tax. Personal checks must clear before shipment. All items sent shipping charges collect unless otherwise agreed. Accessories do not include crystals, relay or antennas.

FM YOUR GONSET

(or your Clegg 22'er, Poly Comm 2, PC 62, Johnson 6N2, Aerotron 500, HA 460, TX 62 or VHF 1)

- New! Plug-in modulator puts the Communicator transmitter on FM.
- No modification or rewiring on your Communicator. Just plug into mike jack and crystal socket.
- Compact self-contained modulator measures 4" x 3" x 1½".



- Works with Communicator I, II, III, IV and GC-105, and other rigs listed.
- FM at a tenth the cost of a new rig.
- Frequency adjust for netting built in.
- \$34.50 postpaid U.S.A. \$36.50 for PC-2, PC-62, HA-460. Specify transmitter model. California residents add 5% sales tax. (HC-6/U crystal and 9 volt transistor battery not supplied.)
- Send for free descriptive brochure.

PALOMAR ENGINEERS

BOX 455, ESCONDIDO, CA 92025

— COIL KITS —

for HIGH EFFICIENCY 35 WATT CLASS D R.F. AMPLIFIER

as described in October "Ham Radio" page 20
L2, T1, T2, T3 Postpaid \$8.25
L1, L3 for 160 meters \$3.50 —
80 meters \$3.30 — 40 meters \$2.90

for MINIATURE 7-MHz TRANSCEIVER

as described in July "Ham Radio" page 16
L1, L2-3, L4, RFC1, 2, L5-6-7 Postpaid \$7.00

SEND FOR LIST OF COIL KITS

Coil Winding Quick Quotes Stock Coils
Send Specs or Sample Coil & Choke Forms



CADDELL COIL CORP.



POULTNEY, VT. 05764 802-287-4055

LEARN RADIO CODE



\$9.95

THE EASY WAY!

- No Books To Read
- No Visual Gimmicks To Distract You
- Just Listen And Learn

Based on modern psychological techniques—This course will take you beyond 13 w.p.m. in LESS THAN HALF THE TIME! Available on magnetic tape \$9.95 — Cassette, \$10.95

Album contains three 12" LP's 2½ hr. Instruction

EPSILON RECORDS

508 East Washington St., Arcola, Illinois 61910



High Performance VHF-UHF Equipment



100 Channel 2 m FM Transceiver SE 285

Immediately ready-for-operation on 100 channels with a frequency spacing of 30 kHz between 145 and 148 MHz. Five preprogrammed repeater or simplex channels can be selected on a rotary switch. All other channels can be selected independently for transmit and receive using thumbwheel switches on the front-panel. Digital frequency selection using a frequency synthesizer. Receiver equipped with KVG 10.7 MHz crystal filter and crystal discriminator. Operating voltage 12 VDC. Completely silicon transistorized. Output power is 10 W RF. Insensitive to incorrectly matched antennas. Built-in squelch, calling tone, and loudspeaker. Connector provided for an external loudspeaker.

\$684

SSB/AM/FM/CW 2 meter Transceiver SE 600 digital



A transceiver that really offers you everything. Extremely low noise figure with excellent selectivity, and high cross and intermodulation rejection.

True transceiver or separate operation of transmitter and receiver, which can be switched independently to the CW, LSB, USB, AM and FM modes. This versatility allows problemless operation via repeaters, satellite and balloon-carried translators.

Digital frequency readout from the built-in frequency counter using 13 mm Nixie tubes. Direct readout of the transmit and receive frequency; the indication jumps from one to the other on depressing the PTT button etc.

Separate crystal filters for each mode. True AM with plate/screen grid modulation. Built-in speech processor. Product detector for SSB and a crystal discriminator for FM. VOX, antitrip and PTT facilities, as well as RF-output and S-meters. Built-in antenna relay. Built-in power supplies for AC and 12 VDC operation.

\$1749

2m/70 cm Linear Transverter LT 702



An all mode transverter (SSB, AM, FM, CW, RTTY, SSTV) for transposing a 2 m signal to the 70 cm band and vice versa. The full 10 MHz between 430 and 440 MHz is covered in five bands of 2 MHz each. Each of these bands can be selected individually for transmit and receive so that it is especially suitable for operation over repeaters and transponders. The receive converter is synchronized to the transmit oscillator during transceive operation. Several coaxial relays are provided for dual band operation 2 m/70 cm and 70 cm/2 m. Output power is 10 W. Built-in meters for drive and output power. Built-in power supply. Built-in attenuator for input power levels of 1 W to 30 W PEP on 2 m.

\$805

Please request our data sheets

Karl Braun • Communications Equipment
D-85 Nuernberg, DeichslerstraBe 13, W. Germany

FREE DATA SHEETS WITH EVERY ITEM 739/749 IC WITH EVERY \$10 ORDER*

- REDUCE YOUR PROJECT COSTS
- MONEY-BACK GUARANTEE
- 24-HOUR SHIPMENT
- ALL TESTED AND GUARANTEED

- **TRANSISTORS (NPN):**
 - 2N3563 TYPE RF Amp & Osc to 1 GHz (pl.2N918) 6/\$1.00
 - 2N3565 TYPE Gen. Purpose High Gain (TO-92/106) 6/\$1.00
 - 2N3567 TYPE High-Current Amplifier/Sw 500 mA 4/\$1.00
 - 2N3866 TYPE RF Pwr Amp 1-2 W @ 100-600 MHz \$1.50
 - 2N3903 TYPE GP Amp & Sw to 100 mA and 30 MHz 6/\$1.00
 - 2N3904 TYPE GP Amp & Sw to 100 mA (TO-92/106) 5/\$1.00
 - 2N3919 TYPE RF Pwr Amp 3-5 W @ 3-30 MHz \$3.00
 - 2N4274 TYPE Ultra-High Speed Switch 12 ns 4/\$1.00
 - MPS6515 TYPE High-Gain Amplifier hFE 250 3/\$1.00
 - Assort. NPN GP TYPES, 2N3565, 2N3641, etc. (15) \$2.00
 - 2N3638 TYPE (PNP) GP Amp & Sw to 300 mA 4/\$1.00
 - 2N4249 TYPE (PNP) Low-Noise Amp 1 μ A to 50 mA 4/\$1.00
- **FET's:**
 - N-CHANNEL (LOW-NOISE):
 - 2N4091 TYPE RF Amp & Switch (TO-18/106) 3/\$1.00
 - 2N4416 TYPE RF Amplifier to 450 MHz (TO-72) 2/\$1.00
 - 2N5163 TYPE Gen. Purpose Amp & Sw (TO-106) 3/\$1.00
 - 2N5486 TYPE RF Amp to 450 MHz (plastic 2N4416) 3/\$1.00
 - E100 TYPE Low-Cost Audio Amplifier 4/\$1.00
 - ITE4888 TYPE Ultra-Low Noise Audio Amp. 2/\$1.00
 - TIS74 TYPE High-Speed Switch 4052 3/\$1.00
 - Assort. RF & GP FET's, 2N5163, 2N5486, etc. (8) \$2.00
 - P-CHANNEL:
 - 2N4360 TYPE Gen. Purpose Amp & Sw (TO-106) 3/\$1.00
 - E175 TYPE High-speed Switch 12552 (TO-106) 3/\$1.00

FEBRUARY SPECIALS:

- 2N3644 TYPE PNP TRANSISTOR GP Amp & Switch 4/\$1.00
- MPE102 TYPE N-CHANNEL FET RF Amp 200 MHz 3/\$1.00
- 741 Freq. Compensated Op Amp (DIP/TO-5/MINI-DIP) 3/\$1.00
- 1N914 or 1N4148 TYPE GP DIODE 100 V/10 mA 15/\$1.00
- MM55316 Digital Alarm Clock Snooze/Alarm/Timer Hrs, Mins, Secs - with Specs/Schematics \$9.95
- MM5736 6-Digit 4-Function Calculator 18 PIN DIP \$3.95

- **LINEAR IC's:**
 - 308 Micro-Power Op Amp (TO-5/MINI-DIP) \$1.00
 - 309K Voltage Regulator 5 V @ 1 A (TO-3) \$1.50
 - 324 Quad 741 Op Amp, Compensated (DIP) \$1.90
 - 380 2.5 Watt Audio Amplifier 34 dB (DIP) \$1.29
 - 555X Timer 1 μ s-1 hr, Dif. pinout from 555 (DIP) \$.85
 - 709 Popular Op Amp (DIP/TO-5) \$.29
 - 723 Voltage Regulator 3.30 V @ 1.250mA (DIP/TO-5) \$.58
 - 739 Dual Low-Noise Audio Preamp/Op Amp (DIP) \$1.00
 - 1458 Dual 741 Op Amp (MINI-DIP) \$.65
 - 2556 Dual 555 Timer 1 μ sec to 1 hour (DIP) \$1.55
- **DIODES:**
 - 1N3600 TYPE Hi-Speed Sw 75 V/200 mA 6/\$1.00
 - 1N3893 TYPE RECTIFIER Stud Mount 400 V/1/2 A 2/\$1.00
 - 1N4608 TYPE GP & Sw 80 V/400 mA 6/\$1.00
 - 1N749 ZENER 4.3 Volt ($\pm 10\%$) 400 mW 4/\$1.00
 - 1N753 ZENER 6.2 Volt ($\pm 10\%$) 400 mW 4/\$1.00
 - 1N755 ZENER 7.5 Volt ($\pm 10\%$) 400 mW 4/\$1.00
 - 1N757 ZENER 9.1 Volt ($\pm 10\%$) 400 mW 4/\$1.00
 - 1N758 ZENER 10 Volt ($\pm 10\%$) 400 mW 4/\$1.00
 - 1N965 ZENER 15 Volt ($\pm 10\%$) 400 mW 4/\$1.00
 - 1N968 ZENER 20 Volt ($\pm 10\%$) 400 mW 4/\$1.00
 - D5 VARACTOR 5.50 W Output @ 30-250 MHz, 7-70 pF \$5.00
 - F7 VARACTOR 1-3 W Output @ 100-500 MHz, 5-30 pF \$1.00

*MAIL NOW! FREE DATA SHEETS supplied with every item from this ad. FREE 739 or 749 Low-Noise Dual Op Amp included (\$1.00 value) with every order of \$10 or more, postmarked prior to 3/31/75.

ORDER TODAY—All items subject to prior sale and prices subject to change without notice.

WRITE FOR FREE CATALOG offering hundreds of semiconductors not listed here. Send 10¢ stamp.

TERMS: All orders must be prepaid. We pay postage. \$1.00 handling charge on orders under \$10. Calif. residents add 6% sales tax.

ADVA ELECTRONICS

BOX 4181-X, WOODSIDE, CA 94062
Tel. (415) 851-0455

FREE CATALOG

CRAMMED WITH GOV'T SURPLUS ELECTRONIC GEAR **WRITE TODAY!**



BC-348 RADIO RECEIVER
200-500 Kc & 1.5 18 Mc. 8-Tube
6-Band Communications Receiver, Excellent
Used, with tubes and Dynamotor
Checked out..... **\$58.50**

BC-342 RADIO RECEIVER with AC
Power Supply, Checked..... **\$69.50**



MILITARY RECEIVER TRANSMITTER
Receiver R-392 URR
Used, clean, repairable **\$125.00**
Transmitter T-195-GRC-19
Used, clean, repairable... **\$50.00**
SCHEMATICS INCLUDED

BRAND NEW BC-645 TRANSCEIVER
EASILY CONVERTED FOR
420MC OPERATION
This equipment originally
cost over \$1000. You get
all in original factory carton.



Dependable Two Way Communication more than 15 miles.
"SPECIAL PACKAGE OFFER" **\$26.95**
TRANSCEIVER ONLY..... **\$15.95**

LOW IMPEDANCE HEADSET
New with Plug, Reg. \$12.50..... **\$1.59**

G & G RADIO ELECTRONICS COMPANY

45 Warren St., Dept. H.J., New York, NY 10007 Ph 212-267-4605
TERMS: F.O.B. NYC 25% deposit with order, balance COD or remittance
in full. MINIMUM ORDER \$5.00. Subject to prior sale and price change.

ALUMINUM TOWERS

- ★ TELESCOPING
- ★ WALL MOUNTED
- ★ GUYED
- ★ FREE STANDING

EXCELLENT FOR:
HAM COMMUNICATIONS
QUALITY MADE • LOW PRICED
ALUMA TOWER DIVISION

FRED FRANKÉ, INC.

BOX 2806HR VERO BEACH, FLA. 32960
PHONE (305) 567-3415
SOME TERRITORIES AVAILABLE

PRINTED CIRCUIT BOARDS

Available for any amateur project appearing
with artwork in any amateur periodical.

Write for complete details and prices

D. L. "Mac" McClaren, W8URX

Printed Circuit Service for the Amateur

19721 Maplewood Ave. Cleveland, Ohio 44135

216-267-3263

LOOKING FOR A NEW CHALLENGE?

... then build a TV camera!



ONLY SOLIDSTATE CAMERA AVAILABLE IN KIT FORM
OR FACTORY ASSEMBLED. COMPLETE KIT WITH VIDEO
TUBE. ONLY \$160.00. POSTPAID DELIVERY ANYWHERE IN
USA, CANADA and MEXICO. OPTIONAL AUDIO SUBCARRIER
\$18.95. WRITE or PHONE NOW FOR COMPLETE CATALOG OF
KITS, PARTS and PLANS. DIAL 403-987-3771.

1301 BROADWAY, N.W. **ATV Research** DAKOTA CITY, NEBR. 68731

Something OLD, Something NEW, Something BORROWED, Something BLUE

TO BE HONEST . . . WE CAN'T REALLY OFFER YOU ANYTHING BORROWED OR BLUE . . . BUT WE CAN OFFER YOU THE . . .

OLD RELIABLES

Motorola T43 series radios. 25 watt, wide or narrow band, convertible to 2 meters. Units come complete with mobile accessories, less ovens & ant.

Were \$75.00 Now \$59.00

Motorola U41GGT . . . 30 watt, transistor power supply mobile for conversion to 6 meters. Units in good physical condx, with mobile accs. as above

Were \$100.00 Now \$79.00

Sleeve chargers for Motorola PT200s and 300s. These units can charge your PT from 6/12VDC or 110VAC

\$29.00

OMNI nicads for HT220. We still have some good used, rapid charge nicads left. A good chance to get a spare at a reasonable price.

\$10.00

SOMETHING NEW AT THE FM PEOPLE

TENNELEC Digital Scanner

Get the ultimate in FM scanning. The Tennelec "Memory Scan" receiver is digitally programable for practically unlimited monitoring of the 5 VHF/UHF bands. 16 channel scan, at the push of a button without ever having to buy crystals. Write or call for spec sheet.

Only \$289

Cushcraft ATTENTION OSCAR BUFFS

. . . Get the most out of your station . . . with the Cush Craft Twist antennas. Simple coaxial phasing gives you the choice vert., horiz., left or right circ., or axial polarization. 12-19dB gain possible. 2 models available.

2 meters Model A144-20T

\$52.00

UHF A432-20T

\$45.00



Larsen Electronics, Inc. Now you can get the famous Larsen line of 6, 2 and UHF mobile antennas with the KULROD whip. Larsen has an antenna for almost any need, starting at under

\$10.00



The performance king of 80-10 Mtr mobile antennas is now available at **The FM People**. In addition we also have the CG144 series 5.2 dB gain 2 meter colinears starting at

\$26.75



We are proud to announce the addition of the HyGain line of antennas and antenna accessories. Now **The FM People** can help you meet ALL of your antenna needs including such classics as the TH6DXX and 18AVT/WB.

TERMS OF SALE: Sales to licensed Radio Amateurs for use on Amateur freqs only. All prices FOB Oak Park, IL. Check with order, COD or you can charge to your BankAmericard or Master Charge.

STORE HOURS: Mon.-Thurs. 9:30-6:00, Fri. 9:30-8:00, Sat. 9:30-3:00. Closed Sun. & Holidays

INQUIRIES WITHOUT ZIP CODE OR CALL . . . NO ANSWER

WANTED: Good used FM & test equipment. No quantity too large or small. Finders fees too.



SPECTRONICS INC.

1009 GARFIELD STREET
OAK PARK, ILL. 60304
(312) 848-6778

AMATEUR SALES ONLY / SPECTRONICS The FM People



**YOU WOULDN'T
START A LOG
IN MARCH**



RIGHT NOW

is the time to order your

75 callbook

Don't wait until 1975 is half over. Get your new Callbooks now and have a full year of the most up-to-date QSL information available anywhere.

The new 1975 U. S. Callbook will have over 300,000 W & K listings. It will have calls, license classes, names and addresses plus the many valuable back-up charts and references you have come to expect from the Callbook.

Specialize in DX? Then you're looking for the new, larger than ever 1975 Foreign Callbook with over 225,000 calls, names and addresses of amateurs outside of the USA.

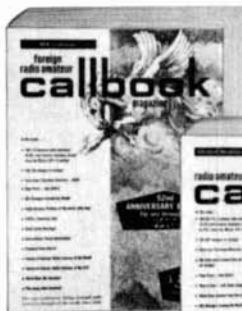

**United States
Callbook**
All W & K Listings
\$12.95

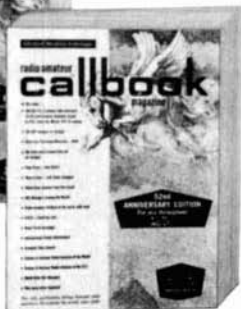

**Foreign Radio
Amateur Callbook
DX Listings**
\$11.95

Order from your favorite electronics dealer or direct from the publisher. All direct orders add 75¢ shipping and handling per Callbook.

WRITE FOR FREE BROCHURE RADIO AMATEUR **callbook** INC.
Dept. E 925 Sherwood Drive
Lake Bluff, Ill. 60044

LOW PRICES ON POPULAR COMPONENTS

IF FILTERS

- Monolithic crystal filters at 10.7 and 16.9 MHz
- Ceramic filters at 455 kHz

SEMICONDUCTORS

- VHF power transistors by CTC-Varian
- J and MOS FETS
- Linear ICs — AM/FM IF, Audio PA
- Bipolar — RF and AF popular types

INDUCTORS

- Molded chokes
- Coil forms — with adjustable cores

CAPACITORS

- Popular variable types

QUALITY COMPONENTS

- No seconds or surplus
- Name brands — fully guaranteed
- Spec sheets on request

GREAT PRICES

- Price breaks at low quantities
- Prices below large mail-order houses

WRITE FOR CATALOG 173

AMTECH, INC.

P. O. BOX 624, MARION, IOWA 52302
(319) 377-7927 or (319) 377-2638

amateur radio's
only air mail
twice monthly
newsletter

hr REPORT
GREENVILLE, NH 03048

a new
standard of
excellence in
news reporting
for today's involved
amateur

1 year — 24 issues — \$12.00

HR Report

Greenville, NH 03048

**NOW
available
for the first time
in North America**



**the all NEW synthesized
VHF FM TRANSCEIVER
the KDK-144**

Compare the features:

- SYNTHESIZED — no more crystals
- L.E.D. READOUT — for quick, easy readability
- 10KHZ FREQUENCY DIAL UP CAPABILITY 146-148 MHZ — Perfect for the 2nd generation of repeaters and simplex channels
- 600 KHZ UP AND DOWN REPEATER CAPABILITY
- POWERFUL 2W AUDIO OUTPUT
- 10W.R.F. OUTPUT

Compare the sizes:

- KDK-144 2" x 6 3/8" x 7 3/4" Deep
- ICOM AC-230 2 9/32" x 6 1/8" x 8 1/2" Deep
- CLEGG FM 27B 3 1/2" x 7 3/8" x 9 1/4" Deep

ONLY
\$399
F.O.B. Blaine Wash.

HAM IMPORT SALES

P.O. Box 1009 Blaine Wash. 98230
(Washington State Residents add 5% Sales Tax)

Please Rush me a KDK-144. Enclosed is a cheque
 money order for \$399. (plus sales tax if applicable)

NAME:
ADDRESS:
ZIP:

HI-T-2

MICROPROCESSORS by Poly Paks!

8008

"THE COMPUTER ON THE CHIP"



\$79.95

16-BIT MICRO PROCESSOR BASIC SYSTEM

\$149.

The lowest-priced 16-bit system! Outperforms the 8008. The CPU (Central Processing Unit) includes 4-MM5760's, called RALU's, and one MM5751 CROM. RALU — called Register and Arithmetic Logic Unit — is a 4-bit control bus, and the CROM is a Control-and-Read-Only Memory. The four RALU's in parallel form a 16-bit unit. The RALU's are controlled by micro-instructions, stored in the CROM. With spec sheets.

Usually called "Microprocessor" — it is a p Channel Si gate MOS 8-bit Parallel Central Processor CPU Central Processing Unit on a chip. Features complete instruction decoding and control. Capability to address 16K x 8 bits of memory (RAM, ROM, SR). Build a micro-computer system when interfacing with other chips, such as 1101, 1303, 2102 (RAMS), etc. With spec sheets. 16-pin dip package. \$79.95
2102 1000-bit "static" Ram for above. \$9.95

6 & 8 DIGIT MINI CALCULATOR BASICS

*So small fits in 'ur palm!
*Easiest basics around!
*Requires approx. 6 more parts. **"The key parts kits"**

KIT NO. 5030 — 6 functions. Includes mini case, with lens, HP nine digit readouts with multiplex pc board, main pc board, mini keyboard (with two switches, percent and constant), ac adapter jack, 2- SN75491 drivers, CT5030 calculator chip with diagram. \$16.95

KIT NO. 5031 — 4 function, same as 5030 except uses CT5030 chip. \$16.95

KIT NO. 5736 — 4 function, like 5031. Uses National MM5736 \$12.95

'ALL LED' MONSANTO READOUTS

MAN-#	MONSANTO CHAR.	SALE	Quantity
	TYPE	HT.	Discounts
<input type="checkbox"/>	MAN-1	.27	3 for \$ 5.
<input type="checkbox"/>	MAN-2	.32*	4 for 3 for \$ 14.
<input type="checkbox"/>	MAN-3	.12	1.00 3 for \$2.50
<input type="checkbox"/>	MAN-6	.60	4.50 3 for \$12.
<input type="checkbox"/>	MAN-64	.4	3.50 3 for \$ 9.
<input type="checkbox"/>	MAN-7	.27	1.50 3 for \$ 3.

MAN-64 *35 LED matrix

THREE QUARTER INCH DIGITS BY OPCOA \$4.95

- 0.7 character
 - 0 to 9
 - 7 Segments
 - 30 mils
- *Plus or Minus one

PRECISION CRYSTAL \$1.95

Excellent time base and other uses. 5.000 MHz. Type HGU case.

6 DIGIT KRONOS CLOCK

6-digits Using MAN-35 Complete KIT \$29.95

7-segment OPCOA SLA-1 REFLECTIVE LED READOUT \$2.50

- Red
 - Yellow
 - Green
- 3 for \$ 6.

"C" THRU S METER \$1.50

Indicates: 0 to 1.5 Plastic case. 1 1/2 x 1 1/2 x 1"

Money-Back GUARANTEE on all items

\$24.50 SIMPLEST! FINEST! SMALLEST!

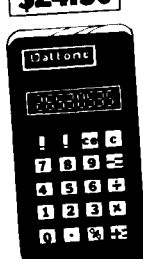

6-FUNCTION AC-DC CALCULATOR KIT!

- Lightweight, pocket size
- Extra large display
- 6 functions plus, minus, times, percentage, constant
- Floating decimal
- Chain and Mix calculations
- True credit balance
- Simplified indexing
- Mark up and Mark down
- Constant multiplication and division • AC adaptor jack

The fewest parts in a kit. Imagine the pc board only has the chip, 4 resistors, two transistors, two driver ic's with the 9 digit readout. SIMPLE! You bet it is our story. Kit includes: attractive black case with red filter; Flex Key (type 20SK-66) 18 key keyboard that OFF, one for K constant; MAIN pc board; readout two 75491 ic drivers; RALU 24-pin calculator chip; ac jack; 9 Volt battery connector resistors; 9 digit array; resistors; back protective plate; necessary wire plugs; easy instructions. (Less 9 volt standard battery and AC adapter) IMAGINE! only 2 1/2 x 1 x 4 1/2".

'BEEPER' AND 'DATER' CLOCK ON THE CHIPS

- MK80250 BEEPER only \$ 8.50
- CT7001 Alarm and Date. \$12.50



CLOCK CHIPS ON A "DIP" as Low as \$4.95

WITH DATA SHEETS	PRICE
MM5311 6-digit 28-Pin	6.95
MM5312 6-digit 28-Pin	6.95
MM5313 6-digit 28-Pin	6.95
MM5314 6-digit 24-Pin	6.95
MM5316 4-digit 40-Pin, Alarm	8.95
MM5316-A no alarm	4.95

SCRs! TRIACS! QUADRACS! SAME PRICE SALE!

10-Amp Power Tab Plastic Units

PRV	Sale
100	\$.75
100	1.95
200	1.25
200	1.80
400	1.95
500	2.25
600	2.50

Inflation-Fighting IC PRICES

Buy 10 15% discount

Buy 100 — Take 25%

order by type number! Spec sheets on request — ONLY!

Type	Sale	Type	Sale	Type	Sale
SN7400	.17	SN7441	.95	SN7489	2.50
SN7401	.17	SN7442	.95	SN7490	.71
SN7402	.17	SN7443	.95	SN7491	.71
SN7403	.17	SN7444	1.05	SN7492	.71
SN7404	.21	SN7445	1.05	SN7493	.85
SN7405	.21	SN7446	1.10	SN7494	.85
SN7406	.23	SN7447	1.10	SN7495	.85
SN7408	.23	SN7448	1.10	SN7496	.85
SN7409	.23	SN7449	1.10	SN7497	.85
SN7410	.18	SN7450	.17	SN7498	.85
SN7411	.27	SN7451	.23	SN7499	.85
SN7412	.27	SN7452	.23	SN7500	.85
SN7413	.73	SN7453	.23	SN7501	.85
SN7414	2.25	SN7454	.23	SN7502	.85
SN7415	.37	SN7455	.37	SN7503	.85
SN7416	.37	SN7456	.37	SN7504	.85
SN7417	.37	SN7457	.37	SN7505	.85
SN7418	.37	SN7458	.37	SN7506	.85
SN7419	.37	SN7459	.37	SN7507	.85
SN7420	.18	SN7460	.37	SN7508	.85
SN7421	.33	SN7461	.49	SN7509	.85
SN7422	.33	SN7462	.33	SN7510	.85
SN7423	.33	SN7463	.41	SN7511	.85
SN7424	.37	SN7464	.41	SN7512	.85
SN7425	.37	SN7465	.41	SN7513	.85
SN7426	.27	SN7466	.41	SN7514	.85
SN7427	.31	SN7467	.41	SN7515	.85
SN7430	.27	SN7468	.41	SN7516	.85
SN7432	.27	SN7469	.41	SN7517	.85
SN7433	.37	SN7470	.41	SN7518	.85
SN7434	.27	SN7471	.49	SN7519	.85
SN7435	.37	SN7472	.33	SN7520	.85
SN7436	.37	SN7473	.41	SN7521	.85
SN7437	.37	SN7474	.41	SN7522	.85
SN7438	.37	SN7475	.41	SN7523	.85
SN7439	.37	SN7476	.41	SN7524	.85
SN7440	.17	SN7477	.41	SN7525	.85
		SN7478	.41	SN7526	.85
		SN7479	.41	SN7527	.85
		SN7480	.41	SN7528	.85
		SN7481	.41	SN7529	.85
		SN7482	.41	SN7530	.85
		SN7483	.41	SN7531	.85
		SN7484	.41	SN7532	.85
		SN7485	.41	SN7533	.85
		SN7486	.41	SN7534	.85

FULL EPOXY SILICON BRIDGE RECTIFIERS

WAVE	PIV	2 Amp	6 Amp	10 AMP
50	\$.98	\$.85	\$ 1.49	
100	.79	.99	1.69	
200	.95	1.25	1.89	
400	1.19	1.50	2.09	
600	1.38	1.75		
800	1.59	1.95		
1000	1.79	2.25		

6 Amp 1/2 x 1/2 x 3/16 sq.

GIANT VENTILATING FAN \$4.98

Heavy-duty powerful high-torque motor, ruggedly constructed. Permanently lubricated type bearings. Thermally protected. Motor size: 3 x 3 x 2 1/2". By Molon ZM04047. 115 vac 60 Hz. 0.77 amps. With 8 1/2 TORIN fan blade. 1500 rpm. For all types of ham & industrial equipment.



flea market



■ **RATES** Commercial Ads 35¢ per word; non-commercial ads 10¢ per word payable in advance. No cash discounts or agency commissions allowed.

■ **COPY** No special layout or arrangements available. Material should be typewritten or clearly printed and must include full name and address. We reserve the right to reject unsuitable copy. **Ham Radio** can not check out each advertiser and thus cannot be held responsible for claims made. Liability for correctness of material limited to corrected ad in next available issue. Deadline is 15th of second preceding month.

■ **SEND MATERIAL TO:** Flea Market, Ham Radio, Greenville, N. H. 03048.

TWO-METER FM ANTENNAS, 1/4; 5/8 W "CAR-TOP"; and fixed station. Unique designs. Send for literature. **MARSH DEVICES**, P. O. Box 154, Old Greenwich, Connecticut 06870 (h)

DO-IT-YOURSELF EXPEDITION — Stay at ZF15B — Cayman Is. Vertical antenna and Caribbean at your doorstep. Diving/fishing if band folds. Write Spanish Bay Reef Resort, Box 800K, Grand Cayman, B. W. I.

BUY—SELL—TRADE. Write for monthly mailer. Give name, address, call letters. Complete stock of major brands new and reconditioned equipment. Call us for best deals. We buy Collins, Drake, Swan, etc. SSB & FM. Associated Radio, 8012 Conser, Overland Park, Ks. 66204. 913-381-5901.

ROCHESTER, N. Y. — Hamfest date of 1975 — May 31st. Marriott Inn is new headquarters. Information? Write WNY Hamfest, Box 1388, Rochester, N. Y. 14603.

ANNUAL AUCTION to be held Friday, February 28th at the United Electronics Institute Building, 1225 Orlen Ave., Cuyahoga Falls, Ohio. Hours are 7 P.M. to 11 P.M. Flyers are available from, Cuyahoga Falls Radio Club, W9VPV, P. O. Box 106, Cuyahoga Falls, Ohio 44222.

TELETYPEWRITERS — Kleinschmidt — portable, fixed, sets, punches, parts, reconditioned, reasonable. Mark/Space Systems, 3563 Conquista, Long Beach, Calif. 90808. 213-429-5821.

STOLEN, FT101 with 160 meters, serial 82L129340/CWF. Stolen November 27th from car of W1FX in Portsmouth, R. I. \$100 reward for return or positive information leading to recovery. W1FX, 401 683-0326.

TWO PLASTIC HOLDERS, frame & display 40 QSL's for \$1.00, or 7 holders enhance 140 cards for \$3.00. Guaranteed & prepaid, TEPABCO, Box 198H, Gallatin, Tennessee 37066.

RECIPROCATING DETECTOR, write Peter Meacham Associates, 19 Loretta Road, Waltham, Mass. 02154.

SELL: Bird #43 Wattmeter, \$75.00; KWM2, \$900; 312B5, \$375.00; 516F2 w/spkr, \$125.00; all round emblem Long Emblem 75S3B, \$575.00; all in A1 condition with manuals. Call Marty, 215-884-6010. Will buy elements for Bird #43 wattmeter.

THE LIVONIA AMATEUR RADIO CLUB will present Michigan's largest swap and swap on February 23, 1975 at Stevenson High School in Livonia. 2 mtr. talk-in on 94 & 52.

DAYTON HAMVENTION at HARA Arena, April 25, 26, 27, 1975. Program brochures mailed March 10th. Write for information if you have not attended the last two years to **HAMVENTION**, P. O. Box 44, Dayton, Ohio 45401.

FLORIDA — Sunshine — Hamfest. Vero Beach, Fl., Feb 15-16. Prizes, speakers, fun, swap shop. \$1.50 adv., \$2 at the door. Vero Beach Community Center. Write Ike Roach, K4QM for info or tickets, Box 3088, Vero Beach, Fl. 32960.

FIGHT TVI with the RSO Low Pass Filter. For brochure write: Taylor Communications Manufacturing Company, Box 126, Agincourt, Ontario, Canada. MIS 3B4.

HRO COIL SETS NEEDED: Want type A, B, C, D and H, but will take any I can get. Also need manual for HRO-W. Price first letter please. Joe Schroeder, W9JUV, Box 406, Glenview, IL 60025.

LEARN DESIGN TECHNIQUES. Electronics Monthly Newsletter. Digital, linear construction projects, design theory and procedures. Sample copy \$1.00. Valley West, Box 2119-C, Sunnyvale, Calif. 94087.

FREE: 12 Extra Crystals of your choice with the purchase of a new Regency HR-2B at \$229. Send cashier's check or money order for same-day shipment. For equally good deals on Drake, Collins, Kenwood, Icom, Ten-Tec, Swan, Atlas, Alpha, Standard, Clegg, Genave, Tempo, Midland, Hy-Gain, Mosley, CushCraft, and Hustler, write to Hoosier Electronics, your ham headquarters in the heart of the Midwest. Become one of our many happy and satisfied customers. Write or call today for our low quote and try our individual, personal service. Hoosier Electronics, R.R. #25, Box 403, Terre Haute, Indiana 47802. (812)-894-2397.

QRP TRANSMATCH for HW7, Ten-Tec and others. Send stamp for details to Peter Meacham Associates, 19 Loretta Road, Waltham, Mass. 02154.

HAWAII HOLIDAY. See our ad in Jan. '75, **HAM RADIO**, p. 81 for details on SAROC's first Hawaiian Holiday and Convention. It'll be too good to miss for sure.

BACK ISSUES — CQ, QST, Ham Radio, Popular Electronics, Electronics World, Radio-Electronics, etc., 3 for \$1.00, Russell, 9410 Walhampton, Louisville, Kentucky 40222.

SURPLUS TEST EQUIPMENT, VHF and microwave gear; write for bulletins. David Edsall, 2843 St. Paul, Baltimore, Md. 21218.

GOVERNMENT SURPLUS — Communications equipment Catalog, Colonel Wayne D. Russell, 9410 Walhampton, Louisville, Kentucky 40222.

TELETYPEWRITER PARTS, gears, manuals, supplies, tape, toroids. SASE list. Typetronics, Box 8873, Ft. Lauderdale, Fl. 33310. Buy parts, late machines.

ATTENTION Hams from Arkansas, Connecticut, Delaware, D. C., Hawaii, Idaho, Maryland, Montana, New Mexico, Oklahoma, and Rhode Island: I need badly an auto license plate with Ham call from your state. If you can furnish, or even supply a lead, please write. Thanks. John Thomas, K4NMT, Box 198, Gallatin, TN 37066.

MANUALS for most ham gear made 1940/65, some earlier. Send SASE for specific quote. Hobby Industry, W2JJK, Box H-864, Council Bluffs, Iowa 51501.

RTTY NS-1 PLL TU wired, tested, guaranteed \$25.95 ppd., less switch, meter, power supply. Board only \$4.75. Nat Stinnette Electronics, Tavares, FL 32778.

QSL's, Sample catalog 20¢. N & S Print, P. O. Box 11184, Phoenix, Ariz. 85061.

TELL YOUR FRIENDS about Ham Radio Magazine.

COOL 30-0-30 V - 2.5 AMP SHIELDED TRANSFORMER — NEW — AMERICAN MADE YES
 — 3 pound with 1 1/2" deep core vertical end bell mount. 2 3/4" w. x 3" h. x 3 1/4" deep, with 6.3 V - 1A winding. \$4.85 ppd.

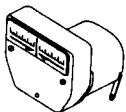

NEW — IMPORTED

MINI-METERS —
 50-0-50 μ A, 1" square, 3/4" deep. Center zero plastic body fits 3/4" dia. or 3/4" x 3/4" opening. White scale can be rear lighted. Ideal for tuning null. \$1.25 ppd.

NEW — UNUSED

ORGAN MFR. OVERRUN

AUDIO AMPLIFIER — Med. Power 4 3/4" x 6"

P.C. PLUG-IN ASSEMBLY

Uses 4 amp-70V

Complimentary

pair output transistors with 2nd

set as drivers. 2 full

wave power supply sections — need only 26 and

5V AC and signal. Complete

Board/untested \$4.80 ppd

63 Components

Tested \$5.75 ppd.

INTEGRATED CIRCUITS

7400	33¢ ea.	741 c Op Amp	55¢ ea.
7473	60¢ ea.	747 Dual Op Amp	\$1.25 ea.
7475	90¢ ea.	723 Regulator	\$1.00 ea.

UNPOTTED TOROIDS — All toroids

are center tapped, 88MHY or 44MHY

Price is a low 5 for \$2.75 ppd.

METER PROTECTOR

Protect that expensive meter. Our proven, tested, guaranteed meter protector will protect your meter movement against 100% overload when installed according to instructions. Price: 75¢ each or 4 for \$2.50 ppd.

PRINTED CIRCUIT BOARD MATERIAL — ALL G10

— Direct from the factory mfg. by Westinghouse. All board is 1/16" with 2 oz. copper.

3" x 3"	45¢
3" x 6"	85¢
6" x 9"	\$2.75
12" x 12"	\$6.00

All ppd. U.S.A.

VERTICAL MOUNT PC BOARD

POTENTIOMETERS

American made (CRL) high quality pots. Available in the following sizes: 25,000 ohms, 50,000 ohms, 100,000 ohms.

Price Is 5 for \$1.00 ppd.



3 inch 4 ohm VC Square frame with 4 mounting holes.

\$1.20 each ppd.

PL-55 TYPE PHONE JACKS

High quality American made jacks. 3/8 inch mounting with hex nut. Extends 1 1/2" behind the panel.

Price: 50¢ each or 3 for \$1.25 ppd.

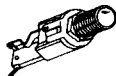

ILLUMINATED ROCKER SWITCH

American made UL approved. Rating: 125 Volt AC 3 Amp 125 Volt DC .5 Amp

DPDT with a 6 volt illuminating bulb. Your choice of color. Red or White. Price Is 80¢ each or buy 3 for \$2.25 ppd. USA



9 PIN SOCKET — SNAP-IN MINIATURE for P.C. Board Mtg. 6 for \$1.00 ppd.

ALUMINUM BATTERY BOX

American made, high quality. Holds two type 'C' cells. All terminals insulated.

55¢ each ppd.

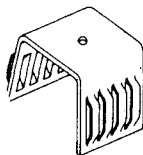
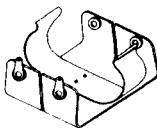

ALUMINUM HEAT SINK

Very nice American made heat sink. 1/16 inch thick and approx. dimensions are 1" x 1" x 1" high with an 1/8 inch hole in the center.

Price is a low 35¢ each or 3 for \$1.00 ppd.



RED NYLON CABLE TIES

BALL-BEAD TYPE — 4 1/4" LONG

Price Is 70 for \$1.00 ppd.

NEW ITEMS

Sperry SP-332 contains two 7 segment readouts, .330 high, side by side layout, black glass face, orange characters with decimal. 3/4 in. square. \$3.50 each, 3 for \$10.00

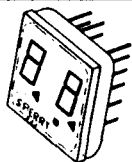

NEW NEW NEW

3/16 inch Dia. LED Lites

Red \$.25 ea. ppd.

Green \$.40 ea. ppd.

Yellow \$.40 ea. ppd.

Super BI-LED — Lites red

with polarity one way and

green when you reverse the

polarity. Neat for many

things. Price is a low \$.75 ea. ppd.



Transformer — 115 Volt Primary — 12 Volt 1.2 Amp Secondary \$2.45 ppd.

JUST ARRIVED — Transformer, 115 VAC primary, 18 volt, 5 amp ccs or 7 amp intermittent duty secondary \$6.00 ea. ppd.

General Purpose Germanium Diodes Similar to 1N34a etc. 16 for \$1.00 ppd. All Cathode banded. 100 for \$5.00 ppd. Full leads. 1000 for \$40.00 ppd.

Transformer — American Made — Fully shielded. 115 V Primary Sec. — 24-0-24 @ 1 amp with tap at 6.3 volt for pilot light. Price — A low \$2.90 each ppd.

Power Transformer. 115 Volt AC Primary. Secondary #1: 32-0-32 Volt @ 1 Amp. Secondary #2: 6.3 Volts. Low Current For Pilot Lights. Size 2 1/2" x 2 1/2" x 3". Price: \$2.50 Each ppd.

1 1/4 inch miniature alligator clips. Bright vinyl red or black insulator. Nickel plated. 9 for \$1.00

SEND STAMP FOR BARGAIN LIST

Pa. residents add 6% State sales tax

ALL ITEMS PPD. USA

Canadian orders for less than \$5.00 add \$1.00 to cover additional postage costs.

m. weinschenker
 K 3DPJ BOX 353 · IRWIN, PA. 15642

STANDARD 851 2-meter transceiver, 22 crystals, 25 watts, mike, speaker, manuals, \$375. VHF Engineering kits, receiver, \$65, transmitter, \$25, amplifier, \$35. Ron Perry, Glen Ave., Fishkill, N.Y. 12524.

WANTED: GENERAL CLASS (or higher) hams to join 4,500 member Morse Telegraph Club. Hundreds of hams already belong. Send modest \$3 annual dues (includes subscription to great slick paper newspaper "Dots and Dashes") to GST A. J. Long, 520 West Schwartz Street, Salem, Ill. 62881 for membership card and assignment to nearest chapter.

THE LaPORTE ARC annual Hamfest-Auction will be held indoors at the Civic Auditorium, 23 Feb. 1975 beginning at 8 A.M. First prize is \$50.00 cash. Advance tickets are \$1.00 each to LPARC, P. O. Box 30, LaPorte, IN 46350. Advance table reservations also available, \$3.00 each. Talk-in on .01-.61 and .94 Simplex. DE WA9GKA.

EXCLUSIVELY HAM TELETYPE 21st year, RTTY Journal, articles, news, DX, VHF, classified ads. Sample 30¢, \$3.00 per year. Box 837, Royal Oak, Michigan 48068.

FOR SALE: HP 524-B COUNTER, tested and calibrated 1974 with 525-A, 525-B, 526-A and 526-B plug in's. FOB Honolulu, \$300.00. Also one SP600-JX sn/2051 in good working condition. FOB Honolulu, \$250.00. KH6ARE, 241-D Hualani St., Kailua, HI 96734.

PC's, Send large S.A.S.E. for list. Semtronics, Rt. #3, Box 1, Bellaire, Ohio 43906.

RESTRUCTURING is coming! More important than ever to upgrade your amateur license. See us for the manuals, guides and code tapes you need to get your license. **HAM RADIO**, Greenville, NH 03048.

ANTENNA TOWER, E-Z Way, tilt-over, self-supporting, steel, telescoping, 25 ft. retracted, 41 ft. extended. Buyer dismantles and transports, \$150. E. Strojny, 3713 Orchard Dr., Midland, MI 48640. (517) 835-3365.

432 MHz TRANSMIT CONVERTER, 5 watt output, 6939 mixer, 6939 amplifier, solid state LO chain. We also have receive converters for 144, 220 and 432 MHz. Send for free information. Carmichael Communications, P. O. Box 256, Carmichael, CA 95608.

FOR SALE: Lampkin 105-B frequency meter Boonton PPM - \$175.00. Larry D. Kuykendall, 212 S. Elm St., Moorefield, W. Va. 26836.

SWAP-N-SELL ADS FREE in TRADIO. Box 4391, Wichita Falls, Texas 76308.

DRAKE R4-A, mint \$250, CV89/URA8 RTTY converter \$85, Hammarlund S-200 speaker \$15. WB4NVJ, 3108 Totopotomy Trail, Ashland, Va. 23005.

HAM OPERATOR WANTED for ketch sailing from Taiwan in March through Singapore to States — share expenses — Contact Captain Hai Newell, No. 17 Chi Yan Road, Pei Tou, Taipei, Taiwan, R.O.C. — phone 892605.

STANDARD 826M 12 channel 2-M FM, 8 sets crystals. Price includes, remote speaker, antenna and cable, \$225.00. Also National G-10-15-20-40-80 meter receiver #NC183D. Asking \$125. Mike Tanner, Rte. #1, Box 275, Milford, N. H. 03055.

WANTED: tubes, transistors, equipment, what have you? Bernard Goldstein, W2MNP, Box 257, Canal Station, New York, N. Y. 10013.

HALLICRAFTERS SX-117, HT-44, PS 150-120, Heath HM-102, Electrovoice 719, plus many accessories, \$400.00 or offer. R. Volpe, R. #2, Box 123, Oscoda, Michigan 48750, 517-739-5551.

COLLINS OWNERS: Why pay \$200 for 200 HZ xtal filters? I have 300 HZ cw/xtal filters for 75S1-75S3B - 75A2 - 75A4 or any 455 kHz I.F. receivers. Collins number X455KF300. These are mil-spec Collins xtal filters metal case in sealed Collins boxes. spec. sheet included. No receiver mods in early 75S3B (before 1968). Few minutes work in other cases, instructions included for 75A4. Tested and Guaranteed, shipped UPS to your door, \$49.95. W1EBC, Gary Firtick, 40 Pilgrim Trail, Woodbury, Conn. 06798. (203) 263-3138.

WORLD QSL — See ad page 87.

SWAN SWAN SWAN

NOW SHIPPING NEW-BOXED 1975 MODEL SWAN 700CX ALL BAND 700 WATT TRANSCEIVER WITH 117XC SPEAKER POWER SUPPLY.

PRICE \$724.90

... WILL ALLOW IN TRADE FOR YOUR ...

SWAN 260 TRANSCEIVER	\$250.00
SWAN 350 WITH 117XC	\$225.00
SWAN 350C WITH 117XC	\$270.00
SWAN 500 WITH 117XC	\$300.00
SWAN 500C WITH 117XC	\$360.00
SWAN 500CX WITH 117XC	\$410.00
SWAN 250C 6 MTR W/117XC	\$350.00
SWAN MARK II LINEAR W/PS	\$450.00
SWAN 14-117 DC/PS	\$ 65.00

SHIP YOUR TRADE-IN INSURED U.P.S. OR PARCEL POST SPECIAL HANDLING PREPAID. UPON RECEIPT WILL SHIP YOUR NEW SWAN 700CX WITH 117XC VIA INSURED U.P.S. PREPAID. WE ACCEPT MASTER CHARGE, CHECK, OR C.O.D. ON BALANCE DUE US.

WRITE OR PHONE TODAY BILL SLEP (704) 524-7519.

SLEP ELECTRONICS  **CO.**

P. O. BOX 100, HIGHWAY 441, DEPT. HR OTTO, NORTH CAROLINA 28763

WORLD QSL BUREAU

THE ONLY QSL BUREAU to handle all of your QSLs to anywhere; next door, the next state, the next country, the whole world. Just bundle them up (please arrange alphabetically) and send them to us with payment of 6¢ each.

5200 Panama Ave., Richmond, CA USA 94804

Craig radio



IC-230 Icom \$489.00

P. O. Box 615 Portsmouth, N.H. 03801

Phone (207) 439-0474 (603) 436-9062

ARR-52 VHF RECEIVER

Easily converted to 2-meter FM. Now set for 163-173 MHz, 16 channels. \$19.95 postpaid continental US. Includes schematic diagram and conversion details. As described in the Surplus Sidelights Column, (Pg. 58 Oct. CQ).



\$19.95



OVER 100 SOLD POSTPAID
BankAmericard & COD Welcome

Electronic Equipment Bank, Inc.

516 Mill Street, N.E. Vienna, Virginia 22180 (703) 938-3350

Truly unique...

...The DV-21 by ICOM

(Phase Locked Digital VFO)



- Designed to work with the IC-21A base/mobile unit.
- Program any frequency you want . . . any frequency split you desire.
- Scan . . . active or inactive frequencies . . . adjustable scan rate.
- LED Digital readout on transmit and receive.
- The ICOM IC-21A and the DV-21 . . . well ahead of their time.



Henry Radio

11240 W. Olympic Blvd., Los Angeles, Calif. 90064 213/477-6701
 931 N. Euclid, Anaheim, Calif. 92801 714/772-9200
 Butler, Missouri 64730 816/679-3127

"World's Largest Distributor of Amateur Radio Equipment"

TRADE: Collins 75S3-B, 32S-3, 312B-4, 516F-2, mint round emblem for late Bendix 1051B or C receiver same condition. Sell mint condx Alpha 77, perfect, \$1200. Sid Sidman, 3571 Gresham Ct., Pleasanton, Calif. 94566.

CANADIAN JUMBO SURPLUS and Parts Catalogs. Bargains Galore. Send \$1. ETCO-HR, Box 741, Montreal "A" H3c 2V2.

TECH MANUALS for Govt. surplus gear, \$6.50 each: R-220/URR, R-274/FRR, URM-25D, URM-32, USM-16, TT-63A/FGC, TS-382D/U, BC-779B, TS-497B/URR, LM-21, TS-34A/AP, ALR-5, GRR-5, ARR-7, TS-323/UR, PRC-10, USM-159. Thousands more available. Send 50¢ (coin) for list. W3IHD, 7218 Roanne Drive, Washington, D. C. 20021.

COMPLETE STATION FOR SALE — SR-400A, SSTV RTTY, two meter, servicing book, etc. Send for list. Cline, Box 216, Logan, Utah 84321.

WHITEWATER, WISCONSIN Midwinter Swapfest, March 16th, 9 a.m. to 5 p.m. at the National Guard Armory, Whitewater. \$1.50 advance, \$2 at the door (additional \$1.50 reserves one display table). Talk-in on 94. Refreshments, free parking, everything indoors. For tickets and details, Dan Servais, WA9AJW, Rt. 4, Box 309AA, Elkhorn, Wis. 53121, Tel. 414-723-2227. S.A.S.E.

HOMEBREWERS: Stamp brings list of high quality components. CPO Surplus, Box 189, Braintree, Mass. 02184.

COLLINS 62-S-1 TRANSVERTER WANTED. \$725 reward for one in mint electrical and mechanical condition. Bob Ewing, WA4GWG, Apt. 7-C, 2160 Hillinger Rd., Augusta, Ga. 30904.

SOCIETY OF WIRELESS PIONEERS offers Life Membership to active and former C.W. operators on comm'l., military, gov't., etc. wireless/radio circuits. Contact: Society of Wireless Pioneers, Dept. H, P. O. Box 530, Santa Rosa, California 95402.

CALCULATOR OWNERS: Use your $\pm \times \div$ calculator to compute square roots, cube roots, trigonometric functions, logarithms, exponentials, and more! Quickly, Accurately, Easily! Send today for the Improved and Expanded Edition of the First and Best Calculator Manual . . . now in use throughout the world . . . still only \$2.00 Postpaid with Unconditional Money-Back Guarantee! Mallmann Optics and Electronics, Dept.-M4, 836 South 113, West Allis, Wisconsin 53134.

YOU'LL READ IT FIRST IN HR REPORT, amateur radio's only air mail newsletter. If you want to know what's really going on, you need this newsletter now. Write for a sample copy and full details. HR REPORT, Greenville, N.H. 03048.

PROUD OF YOUR TICKET? Get this 8 x 10 inch certificate imprinted with the same data as on your ham license. Beautifully printed in two colors on parchment. Licensed amateurs only, any class, \$1.95 ppd. Moneyback guarantee. Send copy of existing license and check or money order to California Marketing Associates, P. O. Box 1195, Los Altos, California 94022.

VERY in-ter-est-ing! Next 5 big issues \$1. "The Ham Trader," Sycamore IL 60178

FOR SALE: 100' T-26 Tri-Ex tower, 5 each 20' sections. Handles 50 sq. ft. of antenna at 100MPH. Complete with guys, hardware, etc. except base. Disassembled in storage. \$16.50 FOB. Late Model Signal/One CX7A, excellent condition, \$895. Write with phone number, W7UR, P. O. Box 1047, Bend, OR 97701.

NOW PAYING \$2000.00 and up for ARC-94/618T ARC-102/618T, \$1200.00 and up for ARC-51BX, \$1500.00 and up for 490T-1 antenna couplers. We also need these control boxes — C-6287/ARC-51BX, C-6476/ARC-51BX, C-714E-2. We also need R-1051 receivers, RT-662/GRC-106 transceivers. We buy all late aircraft and ground radio equipment. Also pack radios. We are buyers not talkers. Bring your equipment in, you are paid on the spot. Ship it in, you are paid within 24 hours. We pay all shipping charges. If you want the best price for your equipment, call us. Call collect if you have, and want to sell or trade. We also sell. What do you need? D & R Electronics, R.D. #1, Box 56, Milton, Pa. 17847. Phone — 717-742-4604 - 9:00 a.m.-9:00 p.m.

UNIVERSAL TOWERS

FREE STANDING ALUMINUM TOWER

10' to 100'
Prices from \$110.00 (30')

**MOST
POPULAR
HAM TOWER**

EVER MADE!

REQUEST
**NEW CATALOG
OF
TOWERS &
ANTENNAS**

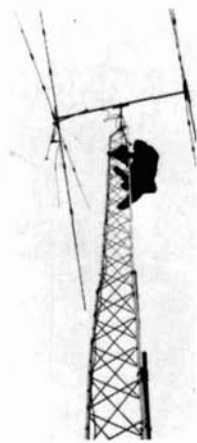

Midwest Ham Headquarters

For Over 36 Years

HAMS! Write For Free Catalog and Wholesale Prices!

ELECTRONIC DISTRIBUTORS, INC.

1960 Peck Muskegon, MI 49441

Tel: 616-726-3196 TELEX: 22-8411

VHF/UHF

**CONVERTERS
PREAMPS**

Ten meters through 432 Mhz. A post card will bring our full 1974 Catalog.



JANEL laboratories

BOX 112, SUCCASUNNA, NJ 07876

Telephone 201 584 6521

ALL-BAND ANTENNA CONNECTOR



HYE-QUE 1 molded connector has eyelets for securing antenna elements, heavy copper leads, coax PL-250 connector for feedline, and tie-point for antenna support. Drip-cap protects connector. Reinforced. At your dealer's, or \$3.95 postpd. Companion insulators, 2 for 99¢ ppd. Instructions included.

BUDWIG MFG. CO., P. O. Box 97H, Ramona, Calif. 92065

RTTY

- Phase-lock loop RTTY PC boards
- CMOS RTTY regenerator PC boards
- Phase-coherent afsk PC boards

AOK for Oscar 7 **DIGICOM** send S.A.S.E. for info.
telemetry **DIGICOM** for info.
Suite 900 185 Devonshire St. Boston, MA 02110

LOGIC
NEWSLETTER [®]

LOGIC MICRO/MINI-
COMPUTER NEWS

SAMPLE COPY \$1.00

LOGIC NEWSLETTER

POB 252

WALDWICK, N.J. 07463



Model CST-50

Our Latest!

VHF Two-Band Transceiver for 2 and 1¼ meters with Digital Frequency Synthesis

The new CST-50 Two-Band Transceiver provides coverage of two complete amateur bands with all the features needed by most operators. Imagine! The two most popular VHF bands in one rig with Phase Locked Loop frequency synthesis. In the CST-50 all frequencies are generated digitally by reference to one highly accurate and easily adjustable crystal. As soon as a new repeater is on you can use it, no waiting for crystals. Write for further information.

- Covers entire 2 meter and 1¼ meter bands
- Covers MARS, CAP and CD frequencies from 142 to 149.995 MHz
- Full digital frequency synthesis with 5 kHz steps
- Lighted thumbwheels for night mobile operation
- No crystals to buy — ever
- Built-in repeater offsets of 600 kHz, 1 Mhz and 1.6 MHz
- 25 watts output on each band
- No transmitter retuning across either band
- FM-AM receiver
- 8 pole crystal filter
- Front mounted speaker

- PTT microphone and mobile mount included
- Operates on 12 volts DC
- AC supply available
- Accessory connector for tone burst and tone coded squelch

CST-50 two-band transceiver \$769.95
 CPS-6 AC power supply \$119.95



MADE IN USA by

COMCRAFT

P.O. BOX 266, GOLETA, CA 93017

QSL'S — BROWNIE W3CJI — 3035B Lehigh, Allentown, Pa. 18103. Samples with cut catalog 35¢.

SIGNAL GENERATORS FOR SALE: Boonton 202B, \$210; AN/URM-25H, \$185; AN/URM-25, \$140; AN/URM-26B, \$225; TS-510A, \$400; Verrold 900A, \$400; James Walter, 2697 Nickel, San Pablo, Ca. 94806.

TELETYPE EQUIPMENT FOR SALE for beginners and experienced operators. RTTY machines, parts, gears. Send us a list of your teletype needs. Atlantic Surplus Sales Co., 1902 Mermaid Ave., Brooklyn, New York 11224. Call us first (212) 266-2629.

POLICE CALL. A complete listing including frequency and location of VHF-UHF public service stations. Nine volumes cover the whole USA. Order the volume for your state. Only \$4.95 plus 25¢ shipping. HAM RADIO, Greenville, N.H. 03048.

PC BOARD. Slight discoloration on some boards. All glass 103. 4 1/4 x 48 1/4 x 3/32, \$2.00. Following 1/16" 2-sided 6 x 18, \$3.00; 9 x 18, \$3.75; 9 x 36, \$6.50. Larger pieces sheared to size, 10¢ cut. Wire 16-2 stranded twisted \$18.00/M; 16-3 twisted, \$27.00/M; 18-2 shielded stranded, \$35.00/M. 16 wire may be in 2-4 pieces, plus post or UPS. Doug Craton, 5625 Balfrey Dr., W. Palm Bch., Fl. 33406.

NEW CANADIAN MAGAZINE. "Electronics Work Shop" \$5.00 yearly, sample \$1.00. ETCOB, Box 741, Montreal, H3C 2V2.

RCA 70/15 PROCESSOR some periph. 70/752 RCA VDT VG with manuals DVX 315 with DT1614 and DT1616 new, NM50 with ps qnd access. Scientific Atlanta 1560 chart type rectangular recorder with 1554-1 and 1555-3 plug-ins. Davidson Optronics D665-107 Auto Collimator, Elgar 200 power source with 401V plug-in FEL 133A phase lock synchronizer, GR auto voltage reg. 1570-ALB3, power stats 120 V 30A 4.2KVA, others. Large SASE. Douglas Craton, 5625 Balfrey Dr., W. Palm Bch., Fl. 33406.

MOBILE IGNITION SHIELDING provides more range with no noise. Available most engines in assembled or kit forms, plus many other suppression accessories. Free literature. Estes Engineering, 543-H West 184th, Gardena, California 90248.

WANTED: ARC-51, 618T1, ARC-102, etc. Have Sony TC-177SD Cassette Decks for trade. A R S Electronics, P. O. Box 34804, L. A., Ca. 90034. (213) 279-1275.

MOTOROLA PORTABLES — Expert repairs, reasonable prices, fast turn-around time. More details and flat rate catalog FREE. Ideal Technical Services, 6663 Industrial Loop, Greendale, WI 53129.

QSLs. SECOND TO NONE. Same day service. Samples airmailed 25¢. Include your call for free decal. Ray, K7HLR, Box 331, Clearfield, Utah 84015.

FM-YOUR KNIGHT TR-108. Complete kit. Use xtal-vfo. 19.95 ppd. Check or M.O. Calif. res. 6%. Revilo Color, 4725 W. Washington Bl., Los Angeles, Ca. 90016.

FREE BARGAIN CATALOG. Transistors, resistors, capacitors, xtals, LEDs, readouts, headphones, micro-miniature parts, unusual electronic components. Chaney's, Box 15431, Lakewood, Colorado 80215.

TRAVEL-PAK QSL KIT — Send call and 25¢; receive your call sample kit in return. Samco, Box 203, Wynantskill, N. Y. 12198.

WHEATON ANNUAL MID-WINTER HAMFEST on Sunday, February 9th at the DuPage County Fairgrounds, Wheaton, Illinois. Hours 8 A.M. to 5 P.M. Tickets are \$1.50 advance; \$2.00 at the door. Free coffee and donuts 9:00 to 9:30 A.M. For information and advance tickets send a stamped self addressed envelope to L. O. Shaw, W9OKI, 433 S. Villa Ave., Villa Park, Ill. 60181. Advance ticket orders must be postmarked no later than February 2, 1975.

PRINTED CIRCUIT TECHNIQUES for the hobbyist. Booklet: \$2.00. H. S. steel and carbide drill bits and PC artwork. Send SASE for flyer. Trumbull, 833 Balca Dr., El Cerrito, Ca. 94530.

YOUR AD belongs here too. Commercial ads 35¢ per word. Non-commercial ads 10¢ per word. Commercial advertisers write for special discounts for standing ads not changed each month.

CALCULATOR CHIP A1030

North American Rockwell A1030
4 function 8 percent: on-chip
clock: 8 digit floating or
fixed DP: full memory and constant
42 pin staggered lead
DIP (unbent).



ea. \$4.95
w/data

74S206 SCHOTTKY BIPOLAR

74S206 Schottky Bipolar 256x1
Random Access Memory.
ea. \$3.49 10 pak \$29.00

10 AMP FULL WAVE BRIDGE RECTIFIER

10 AMP Full Wave Bridge Rectifier
100 PRV Motorola MDA 762-2
ea. \$2.25 10 pak \$20.00



2N3055 NPN TRANSISTOR



2N3055 Transistor (power): PD-115W;
VCE-60V; HFE-50; FT-30K; Case-TO-3
ea. \$1.15 10 for \$6.95

DIP IC NETWORKS



14 and 16 pin IC packages containing
precision resistors and capacitors.
NO SCHEMATICS AVAILABLE
Sample indicates most contain 10 to
15R and 1 or 2C. Assortment of 8, \$1.

All Merchandise is new unused surplus
and is sold on a money back guarantee.

Five dollar minimum order. Free first
class postage on all orders. California
Residents please add sales tax.

Send stamp for free catalog. Write to:

VALU-PAK

box AF Carmichael, Ca. 95608



CURTIS KEYER

CHIP ...

\$24.95

8043-1; IC, PCB, Manual \$24.95

8043-2; Semi-kit \$49.95

Add for postage \$1.50

KB4200 Keyboard \$499.95

See Oct 74 QST

EK420/KM420 Keyer/Memory \$439.90

See Oct 73 QST

Brand New!!! EK430 CMOS Keyer . \$124.95

Brand New!!! IK440 Instructokeyer . \$224.95

CURTIS ELECTRO DEVICES, INC.

Box 4090, Mountain View, CA 94040



RADIO & ELECTRONICS CONSTRUCTOR

- Audio Construction Projects
- Receiver Construction Projects
- Transmitter Construction Projects
- Test Equipment Projects
- Radio Control Projects
- ... and much more

ONE YEAR SUBSCRIPTION — \$8.00

12 MONTHLY ISSUES

Write

RADIO CONSTRUCTOR

Greenville, N. H. 03048

C F P ENTERPRISES

866 RIDGE ROAD, LANSING, N. Y. 14882

HERE IS A VERY SPECIAL RADIO!

STANDARD SR-C826MA WITH RP MFA-22 SYNTHESIZER AND HOME-BREW SCANNER

Trade Price \$575.00 CASH \$468.00

MORE USED EQUIPMENT SPECIALS

Description	Trade	PRICE	Cash
Regency HR-212 with 11 sets of crystals	260.00	221.00	
Standard SR-C826MA with SR-C12/120 AC supply and 5 sets of crystals	285.00	242.00	
Standard SR-C851T12 with RP MFA-22 synthesizer	585.00	497.00	
Heath HW-202 with 7½ sets of Crystals and home-brew regulated AC supply	198.00	198.00	
Icom IC-22 — Used — with extra crystals	205.00	205.00	
SBE SB-144 with 7 sets of crystals — Further Reduced from last listing	183.00	183.00	
Standard SR-C826M — No Crystals	165.00	140.00	
Standard SR-826MA — Used — with 4 channels crystallized	220.00	187.00	
(2) Standard SR-C851 with 7 sets of crystals — 25 watt transceiver	340.00	289.00	
Unimetrics Ultracom 25 with 8 sets of crystals	208.00	208.00	
50 Feet of Air Hardline — 52 ohm — with gauge	45.00	38.00	
Beckman/Berkeley 7170-9 EPUT Meter	180.00	153.00	
Browning MD-33 Modulation Monitor with manual	275.00	234.00	

This is just part of our listing —

Send SASE for Monthly Listing of Used Equipment and Bargain Goodies

Office & Salesroom Hours by Appointment Only
24-Hour Phone: 607-533-4297

radio communication

If you want an excellent technical magazine then this is the one for you. Want to know what British amateurs are up to? This is the only publication which gives complete coverage of amateur radio in Great Britain. Well written and very interesting.

Your subscription also covers a one year membership in the Radio Society of Great Britain.

1 Year (12 issues) \$12.00

Radio Communication

Greenville, NH 03048



RTTY VIDEO DISPLAY UNIT

1000 CHARACTERS—ANY TV SET

VIDITYPE
MODEL 872 \$550
WRITE FOR BROCHURE

LELAND ASSOCIATES

18704 GLASTONBURY RD.
DETROIT, MI. 48219

Cash for any Collins military or commercial equipment or parts, especially 618 T Receivers, 490 T antenna couplers, AN/ARC-102, AN/ARC-94.

CASH

AN/MRC-95, SPACE ELECTRONICS CO.,
76 Brookside Drive, Upper Saddle River, N.J. 07458
(201) 327-7840

CASH FOR 2-WAY FM RADIO MOTOROLA, GE, RCA, ETC. EQUIPMENT

MOBILES, BASES, PORTABLES, MOBILE-TELEPHONES
REPEATERS, REMOTE CONTROLS, TONE EQUIPMENT

— 2-WAY TEST EQUIPMENT —

(Operational Units Only)

- Commissions/Finders Fees •

CAL-COM SYSTEMS, INC.

701-51A KINGS ROW, SAN JOSE, CALIFORNIA 95112

Telephone 24 Hours 408/998-4444

QUALITY, VALUE, INTEGRITY,
VARIETY AND FAST PPD. DELIVERY.

WANT SOME? Try TRI-TEK



10¢ Stamp For Latest Flyers Full of New and Surplus Electronics Bargains.

Tri-Tek, Inc. Box 14206, Phoenix, Az. 85063
Store Location: 6522 N. 43rd Ave., Glendale, Az.

For Your Operating Pleasure — A NEW TUNABLE ACTIVE FILTER

How about a tunable active filter for all modes of operation — CW, RTTY, AM, SSB? We've evolved PEAK-N-NOTCH based upon the latest filter theory and integrated circuit technology to yield unparalleled performance. A single knob tunes a deep rejection notch or a high selectivity peak over the 50 to 5000 Hertz band separating desired from undesired signals by more than 30 dB. Q of the filter may be adjusted to meet your individual preference.



In addition, PEAK-N-NOTCH can be used as a versatile test instrument in harmonic and intermod distortion measurements. Battery power eliminates hum and other A-C line induced signals. Phones, a speaker, and high impedance loads may be used with the filter. Silicon integrated circuits and a premium, hot-moulded tuning pot ensure a long, noise free life. It's so good we offer a two year warranty. Only \$44.50 via parcel post or UPS within the USA. Add \$1.00 for shipment by air, plus any applicable local taxes.

RADIATION DEVICES CO., P. O. Box 8450, Baltimore, MD 21234

NEW!

450 MHz CONVERTER KIT FOR HAM OR COM'L. BANDS, \$20 LESS XTAL(S).

- PREAMP KITS \$6, WIRED \$10 —
FREQ. FROM 20 TO 230 MHz.
- LED SCANNER KITS \$10.
- VHF FM RECEIVER KITS.
- PREAMP FOR 432-450-470 MHz,
KIT \$15/WIRED \$25

— SEND SASE FOR LITERATURE —

HAMTRONICS, INC.

182 BELMONT RD., ROCHESTER, N. Y. 14612

THE ULTRA-BAL 2000

NOW ----- An extremely rugged, weather-proof BALUN!

- Full 2KW, 3-30 MHZ., 1:1 or 1:4 ratios.
- Special Teflon insulation, May be used
with tuned lines and tuners.
- With dipole insulator and hang-up hook.

ONLY \$9.95ppd. (state ratio)

At your dealer or order direct

K.E. Electronics Box 1279, Tustin Calif. 92680

"THE ELECTRONICS STORE" RMS CORPORATION 675A GREAT ROAD (ROUTE 119) LITTLETON, MASS. 01460

7400 SERIES I.C.'s MATRIX-KEYERS
HUSTLER ANT. GOTHAM ANTENNAS
VHF ENG. KITS — VHF-HT-144 — VENUS SSTV
LARGE INVENTORY OF COMPONENTS
I-495 to Rte. 119, Groton Exit 19
2 Miles On The Right

ATT. ALL FT-101 OWNERS

5-10 dB extra talk power. Better
RX gain and selectivity. "Unit
works so well have given up plans
to buy a Linear — W2AQQ!"
Price \$110, post paid. Details
Holdings Ltd., 39/41 Mincing
Lane, Blackburn. BB2 2AF.
England.

G3LLL's RF Clipper



BINDERS

for

HAM RADIO MAGAZINE
\$4.50 each 3 for \$12.00
HAM RADIO, Greenville, N. H. 03048

YOU ASKED FOR IT! ECM-5B FM

Modulation Meter

Only \$99.95 less batteries
and crystals

- 0.7.5 kHz deviation peak reading
- Meets commercial requirements
- Operates 30-500 MHz
- Crystal controlled for easy operation
- Telescopic antenna



- NEW OPTIONS
- NICAD power pak \$20.46
 - Charger \$29.95
 - Audio/Scope output
with earphone \$12.95

Write or call for complete info

Send check or money order for \$99.95 plus \$1.50 for
shipping. Indiana residents add 4% sales tax. Crystals
for 146.94 MHz \$3.95. All other freq. \$7.10.

ECM

ECM Corporation
412 North Weinbach Ave.
Evansville, Indiana 47711
812-476-2121

AMSAT

*The team
that brought
us OSCAR 7.*

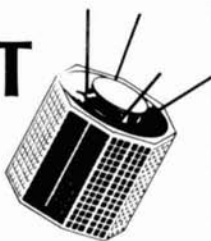

The Radio Amateur Satellite Corporation (AMSAT) is a non-profit, tax-exempt organization founded in the greater Washington, D. C. area five years ago. It is a membership organization open to all radio amateurs and interested non-amateurs. AMSAT's satellite programs are supported entirely from donations, membership dues, and grants.

Join AMSAT. Learn more about how you can participate with the exciting AMSAT-OSCAR 6 communications satellite, and with OSCAR 7 which promises to be even better! Receive the quarterly AMSAT Newsletter with the latest information on this new ham radio frontier. For membership information, write the Membership Committee, AMSAT, P. O. Box 27, Washington, D. C. 20044.



Radio Amateurs
Reference Library
of Maps and Atlas

WORLD PREFIX MAP — Full color, 40" x 28", shows
prefixes on each country . . . DX zones, time zones,
cities, cross referenced tables **\$1.25**

**RADIO AMATEURS GREAT CIRCLE CHART OF THE
WORLD** — from the center of the United States! Full
color, 30" x 25", listing Great Circle bearings in de-
grees for six major U.S. cities; Boston, Washington,
D. C., Miami, Seattle, San Francisco & Los Angeles. **\$1.25**

RADIO AMATEURS MAP OF NORTH AMERICA! Full
color, 30" x 25" — includes Central America and the
Caribbean to the equator, showing call areas, zone
boundaries, prefixes and time zones, FCC frequency
chart, plus useful information on each of the 50
United States and other Countries **\$1.25**

WORLD ATLAS — Only atlas compiled for radio ama-
teurs. Packed with world-wide information — includes
11 maps, in 4 colors with zone boundaries and coun-
try prefixes on each map. Also includes a polar
projection map of the world plus a map of the Antarctica
— a complete set of maps of the world. 20 pages,
size 8 3/4" x 12" **\$2.50**

Complete reference library of maps — set of 4 as listed
above **\$3.75**

See your favorite dealer or order direct.

Mail orders please include 50¢ per order for postage and handling.

**WRITE FOR
FREE
BROCHURE!**

RADIO AMATEUR
callbook INC.



Dept. E 925 Sherwood Drive
Lake Bluff, Ill. 60044

Advertisers check-off

... for literature, in a hurry — we'll rush your name to the companies whose names you "check-off"

Place your check mark in the space between name and number. Ex: Ham Radio 234

INDEX

ATV *	
Adva	265
Amsat	220
Amtech	006
Atlas	198
Barry *	
Bauman	017
Braun	286
Budwig	233
CFP	022
Caddell	247
Cal-Com	282
Clegg	027
Comcraft	028
Craig	177
Cush Craft	035
Curtis	034
Data Signal	270
Dentron	259
Digicom	278
Dycomm	040
DuPage	287
ECM	190
E S Ent.	208
Ehrhorn	042
Eimac	043
Electronic Dist.	044
Elect. Equip. Bank	288
Epsilon	046
Erickson	047
Fred Franke	289
G & G *	
Genave	168
HR Report	150
Hal	057
Ham Import	290
Ham Radio	150
Hamtronics	246
Heights	061
Henry	062
Holdings	252
Hy-Gain	064
Icom	065
International	
Crystal	066
Jan	067
Janel	068
K. E.	072
K-Enterprises	071
Leland	193
Levy	291
Logic	133
McClaren	155
MFJ	082
Matric	084
Nasem	249
Oneida	144
Palomar	093
Poly Paks	096
RMS	239
RP	098
Calbook	100
Radiation Devices	099
Radio Const.	150
Saroc	146
Savoy	105
Signal/One	262
Slep	232
Southwest Tech.	263
Space-Military	107
Spectronics	191
Spectrum	108
Sumner Elect.	
& Eng.	276
Ten-Tec *	
Tri-Ex	116
Tri-Tek	117
Tristao	118
VHF Engineering	121
Valu-Pak	264
Weinschenker	122
World QSL	125

*Please contact this advertiser directly

Limit 15 inquiries per request.

February 1975

Please use before March 31, 1975

Tear off and mail to
HAM RADIO MAGAZINE — "check off"
 Greenville, N. H. 03048

NAME.....
 CALL.....
 STREET.....
 CITY.....
 STATE..... ZIP.....

Advertisers iNdex

ATV Research	80
Adva Electronics	80
Amsat	93
Amtech	82
Atlas Radio Co.	7
Barry	96
Bauman	76
Braun Communications Equipment	79
Budwig Manufacturing Co.	89
CFP Enterprises	92
Caddell Coil Corp.	78
Cal-Com Systems, Inc.	92
Clegg Division of ISC	63
Comcraft	90
Craig Radio	87
Curtis	91
Cush Craft	Cover II
Data Signal, Inc.	76
Dentron Radio Co.	48, 49
Digicom	89
Dycomm	74
DuPage FM, Inc.	88
ECM Corporation	93
E S Enterprises	61
Ehrhorn Technological Operations	1
Eimac, Div. of Varian Assoc.	Cover IV
Electronic Distributors	89, 95
Electronic Equipment Bank, Inc.	87
Epsilon Records	78
Erickson Communications	72
Fred Franke, Inc.	80
G & G Radio Supply Co.	80
General Aviation	69
HR Report	82
Hal Communications Corp.	64, 65
Ham Import Sales	83
Ham Radio	43, 70, 92
Hamtronics, Inc.	93
Heights Manufacturing Co.	57
Henry Radio Stores	88, Cover III
Holdings Photo Audio Centre	93
Hy-Gain Electronics Corp.	35, 95
Icom	5
International Crystal Mfg. Co., Inc.	67
Jan Crystals	74
Janel Labs	89
K. E. Electronics	93
K-Enterprises	72
Leland Associates	92
Levy Associates	76
Logic Newsletter	89
McClaren	80
MFJ Enterprises	66
Matric	72
Nasem	74
New York State Thruway Authority	70
Oneida Elect. Mfg. Co.	66
Palomar Engineers	70, 78
Poly Paks	84
RMS Corporation	93
RP Electronics	66
Radio Amateur Callbook, Inc.	82, 93
Radiation Devices Co.	92
Radio Constructor	91
Saroc	68
Savoy Electronics	73
Signal/One	2
Slep Electronics Co.	87
Southwest Technical Products	77
Space-Military Electronics	92
Spectronics FM	81
Spectrum International	62
Sumner Electronics & Engineering	75
Ten-Tec, Inc.	70
Tri-Ex Tower Corp.	17
Tri-Tek, Inc.	92
Tristao Tower Co.	76
VHF Engineering, Div. of Brownian Elect. Corp.	71
Valu-Pak	91
Weinschenker	86
World QSL Bureau	87

Don't settle for second. Get the best...

hy-gain Antennas!

TH6DXX

6-Element Super Thunderbird DX
Superior Performance TriBand!

Impressive coverage 10-15-20 meters. Separate, improved Hy-Q traps for each band... SWR less than 1.5:1 on all bands. Takes maximum legal power, up to 1 kw AM, 2 kw PEP. Exclusive Beta Match. Factory pre-tuned. Feeds with 52 ohm coax.

TH3Mk3

3-Element Super Thunderbird Popular TriBand Beam Improved!

Outstanding performance 10-15-20 meters at reasonable cost. Separate, matched Hy-Q traps for each band. Exclusive Beta Match for tapered impedance, DC ground. SWR less than 2:1 at resonance. Accepts maximum legal power and feeds with 52 ohm coax.

18AVT/WB

The Great Wide Band Vertical Super Performer 80 through 10 meters!

Superb omnidirectional capabilities. Automatic band switching. Beefed-up Hy-Q traps. Top loading coil. True 1/4 wave resonance on all bands. SWR 2:1 or less at band edges. Outstanding low radiation pattern. Entirely self-supporting.

18 HT

Incomparable Hy-Tower Finest Multiband on the Market!

Automatic band selection 80 through 10 meters. Unique stub decoupling system isolates electrical 1/4 wavelengths for each band. Takes maximum legal power. Feeds with 52 ohm coax. 24' tower is entirely self-supporting, virtually indestructible. Requires only 4 sq. ft. for installation.

GECC revolving credit available
Use your BankAmericard or Master Charge

ELECTRONIC DISTRIBUTORS, INC.

• Communications specialists for over 35 years.

1960 Peck Street, Muskegon, MI 49441 616/726-3196 Telex 228-411

Bird

We are official distributors for all Bird products
 Bird Model 43 Wattmeters with either N or
 SO239 connectors \$100.00
 2 to 30 MHz Slugs. Specify power. \$35.00
 Most VHF Slugs. Specify Power & Freq. \$32.00
 Slugs subject to factory availability

Drake - Official factory distributor

Drake T-4XC \$580.00
 Drake R-4C Receiver \$549.00
 TR-22C Transceiver \$229.95
 Drake TR-4C Transceiver \$599.95
 Drake AC-4 Power Supply \$120.00
 Drake W-4 Wattmeter \$62.00
 Drake WV-4 Wattmeter \$74.00
 Drake MN-2000 Matching Network \$200.00
 T4X-B, R4-B, AC-4. Trade-in Special Write

Finest SSTV **VENUS** Latest Models
 Ready to Operate
 SS-2, SLOW SCAN MONITOR - \$349.00
 C1, FAST SCAN/SLOW SCAN
 CAMERA & CONVERTER - \$469.00

Antennas TA-33, TA-36, TH6-DXX, etc.

Savoy DGA-4075, 40-75 meter dipole \$59.50
 Savoy DGA204075 dipole \$79.50
 Savoy DGA-2M, 2 meter collinear \$29.95
 Trunk lip bracket for DGA-2M \$14.95
 HyGain 1/4 wave 2M grid plane for fixed station
 \$13.00

CushCraft Blitzbug LAC-2 lightning arrester, PL-
 259 both ends \$4.45
 LAC-1 PL-259 & SO-239 \$3.95
 B & W 376 5 position grounding Protax coax
 switch \$17.95
 CushCraft A-147-4, 2m, 4 elem. beam \$13.50
 CushCraft A-147-11 \$23.95
 CushCraft A-147-22 \$68.50
 CushCraft New Ringo ARX-2 6dB \$26.50
 CushCraft A-430-11 \$18.95
 Hustler 4 BTV Vertical Antenna \$79.95
 HyGain 18V 10-80 m. vertical \$33.00
 HyGain BN86 Deluxe Balun \$15.95
 HyGain 18 AVT/WB 10-80 meters vertical \$97.00
 Newtronics G-6-144A deluxe 6 dB Base Antenna
 \$52.95
 Newtronics CGT-144 5.2 dB gain. Trunk lip
 mount \$39.95
 Gold Line Single Pole, 5 position coaxial switch,
 wall bracket or panel mount, 1 KW AM \$17.95
 Times Wire & Cable, T-4-50, RG-8 foam 28¢/ft.

C.D. Ham II Rotator

New Improved \$159.95 net **\$139.95**
 SAVE \$20

CD-44 \$99.95

All rotators with control box
 8 conductor cable for HAM II or CD-44 16¢/ft.

Regulated Pwr Supply 5-50 vdc, steps of 5v
 50ma, 150ma, 500ma, 1.5 amp with meter
 good \$59.95
 10 Volt Fil. Transformer, herm. sealed, 115 V
 50/60 cps, 11.2 vct, 31 amp. 6H x 5 x 5 \$14.95
 FR-114U Freq. & Interval Counter, 20-1,000,000
 cycles, exclnt working cond. \$195.00
 Hammarlund Dual Section 320/320 per section
 Xmit'g Capacitor \$24.95
 B & W 850A PiNet Band switching inductor for
 4-1000A, etc. \$66.75
 852 for 3-1000Z, 4CX-1000A \$66.75
 CONSTANT VOLTAGE TRANSFORMER. Input 115
 VAC @ 60 Hz output, 24 Volts @ 15 amps regulated
 (plus or minus 1%) requires 6 mfd. 660
 VAC capacitor add \$4.95 \$60 value \$14.95 ea.

From VHF Engineering

HT Kit 2 watts out, 4 channel 2 meter transceiver
 kit HT-144B w/1 set xtls \$129.95
 RX 144C 2 meter receiver kit, .3µv sens. 2
 watt audio \$69.95
 TX 144 Transmitter kit \$29.95
 PA110/10 Amplifier, wired \$179.95

HF Gear from Barry

Kenwood TS-520 \$629.00
 Millen 92200 Transmatch Write
 Famous Triton-II by Ten-Tec. Fully solid-state, 200
 watt transceiver. 5 bands — full break in on
 CW \$669.00
 Ten-Tec 262 AC Power Supply with VOX \$129.00
 R-389/URR 15 to 1500 kc. Manual or motor
 tuned with digital readout. Very good. \$395.00
 Millen, Solid State Dipper 1.7-300 MHz Model
 90652 \$138.00
 Kenwood R-599a \$395.00
 2M Converter for 599A \$25.00
 Speaker Sold only with 599A \$15.00
 Nye (Johnson) 52 ohm low pass filter \$19.50
 Nye Heavy Duty transmitting Key \$9.95
 Nye 275 Watts Matchbox with relay \$22.00

NPC POWER SUPPLIES

115 VAC Input - 12 VDC 4 amps out \$29.95
 Same as above but regulated! \$47.95
 Model 108R — 115 VAC/13.6 VDC 8 amps
 continuous 12 amps surge. Regulated \$69.95

Tube Headquarters. Diversified Stock. Heavy
 Inventory of Eimac tubes, chimneys, sockets,
 etc. 3-500Z or 3-400Z Specify \$50.00
 4CX-1000A Special Unused Surplus \$125.00
 572-B \$21.95
 Tubes for worldwide and domestic, commercial
 service.

IC-230

- 162+ channels, simplex or offset (600 kHz) for repeaters
 - All modular construction
 - Super hot MOSFET/helical coil .4µV rcvr
 - AVAILABLE NOW! . . . only \$489.00
- IC-230 Regulated Pwr. Supply \$89.95

From Barry

Just Arrived: Brimstone 144-2M Synthesized
 transceiver Call or write
 Deluxe Headsets, Telex and others for ham radio
 or audio visual: 600 ohms, vinyl cushioned: \$9.99
 With volume control \$11.99
 Gonset 3063 2 Meter Amplifier, built-in P.S.
 Pair 826's, 100w exclnt \$175.00
 Standard 826MA Trade-ins Write
 Clegg FM-27B, 146-148 Mc coverage. Fully synthe-
 sized 25 w. out. Latest model. Write or call
 031 Power Supply for FM-27B \$89.95
 Collins 152-J1 Phone Patch, good, removed from
 equip. with detailed schematic \$24.95
 DYCOMM Block Booster "D" Kit, 10-15 watts in
 45-55 watts out continuous Sale \$59.95
 DYCOMM Brick Booster "E" Kit, 1-3.5 watts in
 12-30 watts out \$59.95
 MA-2 2 meter pre-amp w/instructions \$16.95
 Astatic D-104 Mike new \$23.70
 Astatic UG-8 Stand for D-104 new \$17.97
 Mallory UHF Inductance, covers 50-250Mc \$9.95 ea.
 SWR Bridge less meter by Automatic Electric.
 To 800 Mcs, see July '74 CQ pg. 43 TNC
 connectors, \$100 value \$19.95
 See Barry for thousands of unadvertised specials
BARRY BUYS UNUSED TUBES Send Your List.

BARRY 512 Broadway NY, NY 10012

DEPT. H-2

212-WA-5-7000

TELEX 12-7670

ELECTRONICS

BARRY'S BIRTHDAY FEB. 23
 Open House Week Before & Week After

top quality... top value... fm by tempo

Tempo's VHF transceivers offer commercial performance at amateur prices. Compare these transceivers with any other available. Compare their performance, their quality of construction, their ease of maintenance, and then compare prices. Your choice will have to be Tempo.



TEMPO/CL 146

The CL-146 offers operation on the 146 MHz amateur band. The price includes a microphone power cord, mounting bracket and one pair of crystals. A full line of accessories is also available.

- 12 channel capability • 13 watts or a power savings 3 watts
- All solid state, 12 VDC • 144 to 148 MHz (any two MHz without retuning) • Supplied with one pair of crystals • RF output meter, S-meter, receiver detector meter • Provisions for external oscillator • Monitor feature • Audio output at front panel
- Internal speaker • The Price: \$299.00

TEMPO/CL 220



As new as tomorrow! The superb CL-220 embodies the same general specifications as the CL-146, but operates in the frequency range of 220-225 MHz (any two MHz without retuning). At \$299.00 it is undoubtedly the best value available today.

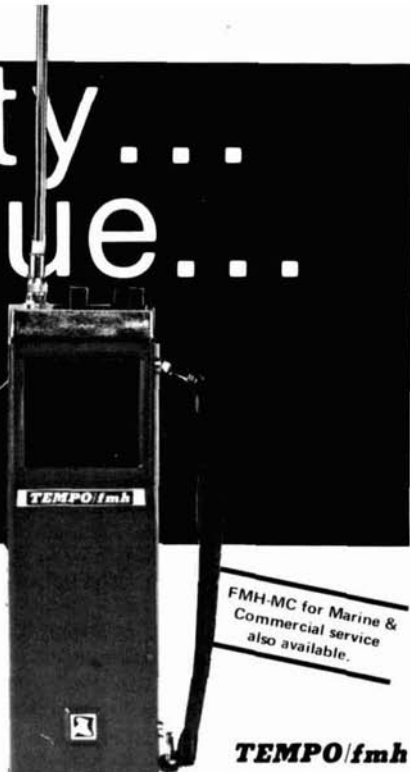

TEMPO/fmh

So much for so little! 2 watt VHF/FM hand held. 6 Channel capability, solid state, 12 VDC, 144-148 MHz (any two MHz), includes 1 pair of crystals, built-in charging terminals for ni-cad cells, S-meter, battery level meter, telescoping whip antenna, internal speaker & microphone. \$199.00



TEMPO VHF/UHF Power Amplifiers

Solid state power amplifiers for use in most land mobile applications. Increase the range, clarity, reliability and speed of two-way communications.

VHF (135 to 175 MHz)			
Drive Power	Output	Model No.	Price
2W	130W	130A02	\$199
10W	130W	130A10	\$179
30W	130W	130A30	\$189
2W	80W	80A02	\$169
10W	80W	80A10	\$149
30W	80W	80A30	\$159
UHF (400 to 512 MHz)			
2W	70W	70D02	\$270
10W	70W	70D10	\$250
30W	70W	70D30	\$210
2W	40W	40D02	\$180
10W	40W	40D10	\$145
2W	10W	10D02	\$125

FCC Type accepted models also available. Please write.

Henry Radio

11240 W. Olympic Blvd., Los Angeles, Calif. 90064 213/477-6701
931 N. Euclid, Anaheim, Calif. 92801 714/772-9200
Butler, Missouri 64730 816/679-3127

AVAILABLE AT SELECT DEALERS THROUGHOUT THE U.S.

Prices subject to change without notice.

TV Station Executives...

EIMAC's 1975-model 8963 TV triode saves you money six ways.

When you purchase your new TV transmitter with EIMAC's 8963 the new 25 kW power triode, you benefit six ways: 1. The 8963 saves 1200 watts per hour in filament and screen power over a tetrode. That's over \$250 a year in your pocket*. 2. The new-design ripple fin radiator of the 8963 gives better and quieter cooling with reduced blower power requirements. 3. The 8963's cool cathode and husky grid structure mean lower internal temperature and increased reliability. 4. Simple triode circuitry reduces components and results in less downtime and failures. 5. EIMAC's 3,000 hour warranty is a potential savings on tomorrow's tube replacement cost. 6. The 8963 gives you the gain and performance of a tetrode with the economy and circuit stability of a triode.



Put dollars in your pocket and enjoy improved transmitter reliability with the EIMAC 8963. For complete details, ask your TV equipment distributor or write EIMAC, Division of Varian, 301 Industrial Way, San Carlos, California 94070. Or contact any of the more than 30 Varian/EIMAC Electron Device Group Sales Offices throughout the world.

Eimac
division
varian

*Based on an 18 hour transmitting day at 3¢ per kWh—and rates are going up (Business Week, Oct. 5, 1974).